

# Service Service Service

**RTV servis Horvat**

Tel: ++385-31-856-842

Tel/fax: ++385-31-856-139

Mob: 098-788-319

[www.rtv-horvat-dj.hr](http://www.rtv-horvat-dj.hr)

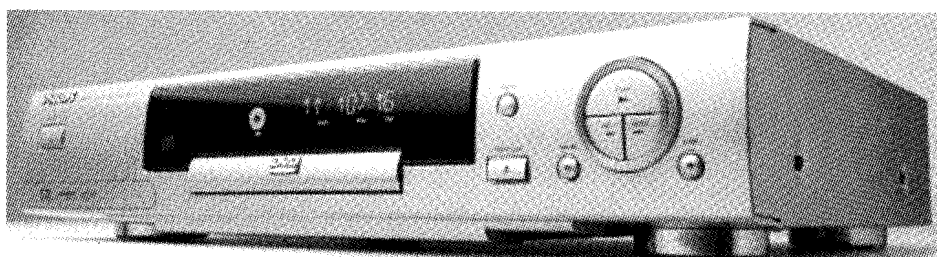

CL06532049\_001.eps  
250400

# Service Manual

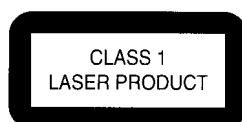

## Contents

	<b>Page</b>
1 Technical specifications and connection facilities	2
2 Warnings and laser safety instructions	3
3 Directions for use	5
4 Service hints	22
5 Block diagram	23
Dismantling instructions	24
Exploded view	25
Wiringdiagram	26
6 <i>Electrical diagrams and print-layouts</i>	<i>Diagram PWB</i>
Volume / Standby (Diagr. C1/D1)	27 27
Display panel	28 29
Trouble shooting Display Board	30
Trouble shooting A/V Board	30
Oscillograms	32
A/V Boards (Diagr C1-C3)	33-35 36-38
7 Diagnostic software and Script interfaces	39
8 Interactive tests	41
9 Test instructions Display board	48
11 List of abbreviations	50
12 Spare parts list	51

©Copyright reserved 2000 Philips Consumer Electronics B.V. Eindhoven, The Netherlands. All rights reserved. No part of this publication may be reproduced, stored in a retrieval system or transmitted, in any form or by any means, electronic, mechanical, photocopying, or otherwise without the prior permission of Philips.



# 1. Technical specifications

## Specifications

### <None>PLAYBACK SYSTEM

DVD-Video  
Video CD  
CD (CD-R and CD-RW)

### OPTICAL READOUT SYSTEM

Lasertype	Semiconductor AlGaAs
Numerical Aperture	0.60 (DVD) 0.45 (VCD/CD)
Wavelength	650 nm (DVD) 780 nm (VCD/CD)

### DVD DISC FORMAT

Medium	Optical Disc	
Diameter	12cm (8cm)	
Playing time (12cm)	One layer	2.15 h <sup>*</sup>
	Dual layer	4 h <sup>*</sup>
	Two side	4.30 h
	Single layer	
	Two side	8 h <sup>*</sup>
	Dual layer	

### TV STANDARD

	EUROPE (PAL/50Hz)	USA (NTSC/60Hz)
Number of lines	625	525
Playback	Multistandard	(PAL/NTSC)

### VIDEO FORMAT

DA Converter	10 bits
Signal handling	Components
Digital Compression	MPEG2 for DVD, MPEG1 for VCD

### DVD

Horiz. Resolution	720 pixels**	720 pixels**
Vertical Resolution	576 lines	480 lines

### VCD

Horiz. Resolution	352 pixels	352 pixels
Vertical Resolution	288 lines	240 lines

### VIDEO PERFORMANCE

Video output	1 Vpp into 75 ohm
S-Video output	Y: 1 Vpp into 75 ohm C: 0.3 Vpp into 75 ohm
Y	1 Vpp into 75 ohm
Cr	0.7 Vpp into 75 ohm
Cb	0.7 Vpp into 75 ohm
Black Level Shift	On/Off
Video Shift	Left/Right

### AUDIO FORMAT

Digital	MPEG DTS/AC-3 PCM	Compressed Digital  16, 20, 24 bits fs, 44.1, 48, 96 kHz
---------	-------------------------	---

Analog Sound Stereo

Dolby Pro Logic downmix from AC-3 multi-channel sound

3D Sound for virtual 5.1 channel sound on 2 speakers

### AUDIO PERFORMANCE

DA Converter	24 bits
DVD	fs 96 kHz      4 Hz - 44 kHz fs 48 kHz      4 Hz - 22 kHz
Video CD	fs 48 kHz      4 Hz - 22 kHz
CD	fs 44.1 kHz    4 Hz - 20 kHz
Signal-Noise (1kHz)	103 dB
Dynamic Range (1kHz)	98 dB
Crosstalk (1kHz)	115 dB
Distortion and Noise (1kHz)	95 dB

### CONNECTIONS

S-Video Output	Mini DIN, 4 pins
Component Video	Y                      Cinch (green) U (Cr)                Cinch (blue) V (Cb)                Cinch (red)
Video Output	Cinch (yellow) 2x
Audio L+R output	Cinch (white/red) 2x
Digital Output	1 coaxial, 1 optical IEC958 for CDDA / LPCM IEC1937 for MPEG1/2 ,AC-3 and DTS

### CABINET

Dimensions (w x h x d)	435 x 92 x 320mm
Weight	Approx. 4 Kg

### PACKAGE CONTENTS

DVD-Video Player  
Remote Control & Batteries  
AC power cord  
User Manual  
Audio cable  
Video cable

### GENERAL FUNCTIONALITY

Stop / Play / Pause  
Fast Forward / Backward  
Time search  
Step Forward / Backward  
Title / Chapter / Track Select  
Skip Next / Skip Previous  
Repeat (Chapter / Title / All) or (Track / All)  
A-B Repeat  
Shuffle  
Enhanced ease of use graphical interface  
Perfect Still with digital multi-tap filter  
Zoom (x1.33 x2. x4) with picture enhancement  
3D Sound  
Virtual Jog Shuttle  
Audio and video bit rate indicator

### DVD FUNCTIONALITY

Multi-angle Selection  
Audio Selection (1 out of max. 8 languages)  
Subtitles Selection (1 out of max. 32 languages)  
Aspect Ratio conversion (16:9, 4:3 Letterbox, 4:3 Pan Scan)  
Parental Control and Disk Lock  
Disc Menu support (Title Menu and Root Menu)  
Resume (5 discs) after stop / standby  
Screen Saver (Dim 75% after 15 min.)  
Programming Titles/chapters with Favorite Selection

### VIDEO CD FUNCTIONALITY

Playback Control for VCD 2.0 discs  
Parental Control and Disc lock  
Resume (5 discs) after stop / standby  
Screen Saver (Dim 75% after 15 min.)  
Programming Tracks with Favorite Selection

### AUDIO CD FUNCTIONALITY

Time Display (Total / Track / Remaining Track Time)  
Full audio functionality with remote control  
Programming with Favorite Track Selection

<sup>\*</sup> typical playing time for movie with 2 spoken languages and 3 subtitle languages.  
<sup>\*\*</sup> equivalent to 500 lines on your TV

Specifications subject to change without prior notice

## 2. Warnings and Laser safety instructions

### GB WARNING

All ICs and many other semi-conductors are susceptible to electrostatic discharges (ESD). Careless handling during repair can reduce life drastically.  
When repairing, make sure that you are connected with the same potential as the mass of the set via a wrist wrap with resistance.  
Keep components and tools also at this potential.



### NL WAARSCHUWING

Alle IC's en vele andere halfgeleiders zijn gevoelig voor elektrostatische ontladingen (ESD).  
Onzorgvuldig behandelen tijdens reparatie kan de levensduur drastisch doen verminderen.  
Zorg ervoor dat u tijdens reparatie via een polsband met weerstand verbonden bent met hetzelfde potentiaal als de massa van het apparaat.  
Houd componenten en hulpmiddelen ook op hetzelfde potentiaal.

### F ATTENTION

Tous les IC et beaucoup d'autres semi-conducteurs sont sensibles aux décharges statiques (ESD).  
Leur longévité pourrait être considérablement écourtée par le fait qu'aucune précaution n'est prise à leur manipulation.  
Lors de réparations, s'assurer de bien être relié au même potentiel que la masse de l'appareil et enfiler le bracelet serti d'une résistance de sécurité.  
Veiller à ce que les composants ainsi que les outils que l'on utilise soient également à ce potentiel.

### D WARNUNG

Alle IC und viele andere Halbleiter sind empfindlich gegen elektrostatische Entladungen (ESD).  
Unvorsichtige Behandlung bei der Reparatur kann die Lebensdauer drastisch vermindern.  
Sorgen sie dafür, das Sie im Reparaturfall über ein Pulsarmband mit Widerstand mit dem Massepotential des Gerätes verbunden sind.  
Halten Sie Bauteile und Hilfsmittel ebenfalls auf diesem Potential.

### I AVVERTIMENTO

Tutti IC e parecchi semi-conduttori sono sensibili alle scariche statiche (ESD).  
La loro longevita potrebbe essere fortemente ridatta in caso di non osservazione della piu grande cauzione alla loro manipolazione.  
Durante le riparazioni occorre quindi essere collegato allo stesso potenziale che quello della massa dell'apparecchio tramite un braccialetto a resistenza.  
Assicurarsi che i componenti e anche gli utensili con quali si lavora siano anche a questo potenziale.

### GB

Safety regulations require that the set be restored to its original condition and that parts which are identical with those specified be used.

### NL

Veiligheidsbepalingen vereisen, dat het apparaat in zijn oorspronkelijke toestand wordt terug gebracht en dat onderdelen, identiek aan de gespecificeerde worden toegepast.

### D

Bei jeder Reparatur sind die geltenden Sicherheitsvorschriften zu beachten.  
Der Originalzustand des Gerats darf nicht verändert werden.  
Für Reparaturen sind Original-Ersatzteile zu verwenden.

### I

Le norme di sicurezza esigono che l'apparecchio venga rimesso nelle condizioni originali e che siano utilizzati pezzi di ricambio identici a quelli specificati.

### F

Les normes de sécurité exigent que l'appareil soit remis à l'état d'origine et que soient utilisées les pièces de rechange identiques à celles spécifiées.

### SHOCK, FIRE HAZARD SERVICE TEST:

**CAUTION:** After servicing this appliance and prior to returning to customer, measure the resistance between either primary AC cord connector pins (with unit NOT connected to AC mains and its Power switch ON), and the face or Front Panel of product and controls and chassis bottom,  
Any resistance measurement less than 1 Megohms should cause unit to be repaired or corrected before AC power is applied, and verified before return to user/customer.  
Ref.UL Standard NO.1492.

### NOTE ON SAFETY:

Symbol : Fire or electrical shock hazard. Only original parts should be used to replace any part with symbol Any other component substitution (other than original type), may increase risk of fire or electrical shock hazard.

## LASER SAFETY

This unit employs a laser. Only a qualified service person should remove the cover or attempt to service this device, due to possible eye injury.

### LASER DEVICE UNIT

Type:	SemiconductorlaserGaAIAs
Wave length:	650 nm (DVD) 780 nm (VCD/CD)
Output Power:	7 mW (DVD) 10 mW (VCD/CD)
Beam divergence:	60 degree



**USE OF CONTROLS OR ADJUSTMENTS OR PERFORMANCE OF PROCEDURE OTHER THAN THOSE SPECIFIED HEREIN MAY RESULT IN HAZARDOUS RADIATION EXPOSURE.**

### AVOID DIRECT EXPOSURE TO BEAM

### WARNING

The use of optical instruments with this product will increase eye hazard.  
Repair handling should take place as much as possible with a disc loaded inside the player

### WARNING LOCATION: INSIDE ON LASER COVERSIELD

**CAUTION** VISIBLE AND INVISIBLE LASER RADIATION WHEN OPEN AVOID EXPOSURE TO BEAM  
**ADVARSEL** SYNLIG OG USYNLIG LASERSTRÅLING VED ÅBNING UNDGÅ UDSÆTTELSE FOR STRÅLING  
**ADVARSEL** SYNLIG OG USYNLIG LASERSTRÅLING NÅR DEKSEL ÅPNES UNNGÅ EKSPONERING FOR STRÅLEN  
**VARNING** SYNLIG OCH OSYNLIG LASERSTRÅLNING NÅR DENNA DEL ÅR ÖPPNAD BETRAKTA EJ STRÅLEN  
**VARO!** AVATT AESSA OLET ALTTIINA NÄKYVÄLLE JA NÄKYMÄTTÖMÄLLE LASER SÄTEILYLLE. ÄLÄ KAT SO SÄTEESEEN  
**VORSICHT** SICHTBARE UND UNSICHTBARE LASERSTRAHLUNG WENN ABDECKUNG GEÖFFNET NICHT DEM STRAHL AUSSETZEN  
**DANGER** VISIBLE AND INVISIBLE LASER RADIATION WHEN OPEN AVOID DIRECT EXPOSURE TO BEAM  
**ATTENTION** RAYONNEMENT LASER VISIBLE ET INVISIBLE EN CAS D'OUVERTURE EXPOSITION DANGEREUSE AU FAISCEAU

## Warning for powersupply on position 1005

**The primary side of the powersupply including the heatsink carries live mains voltage when the player is connected to the mains even when the player is swiched off !**

This primary area is not shielded so it is possible to touch copper tracks and/or components when servicing the player. Service personnel have to take precautions to prevent touching this area or components in this area .

The primary side of the powersupply has been indicated with a lightning stroke and a stripe-marked printed on the printed wiring board

### Note:

**The screws on the basic Engine (position 218 in on the exploded viewdrawing) may never be touched removed or re-adjusted.**

**Handle the Basic engine with care when the unit has to be exchanged!**

**The mechanism of the basic engine is very sensative for dropping or shocks**

### 3. Directions for use

**NEVER MAKE OR CHANGE CONNECTIONS WITH THE POWER SWITCHED ON.**

**CAUTION**

VISIBLE AND INVISIBLE LASER RADIATION WHEN OPEN AVOID EXPOSURE TO BEAM (WARNING LOCATION: INSIDE ON LASER COVERSIELD)

**NOTE:**  
PICTURES SHOWN MAYBE DIFFERENT BETWEEN COUNTRIES.

TruSurround and the SRS symbol are trademarks of SRS Labs., Inc. TruSurround technology is manufactured under license from SRS Labs., Inc.

**TruSurround™**  
with **SRS** 

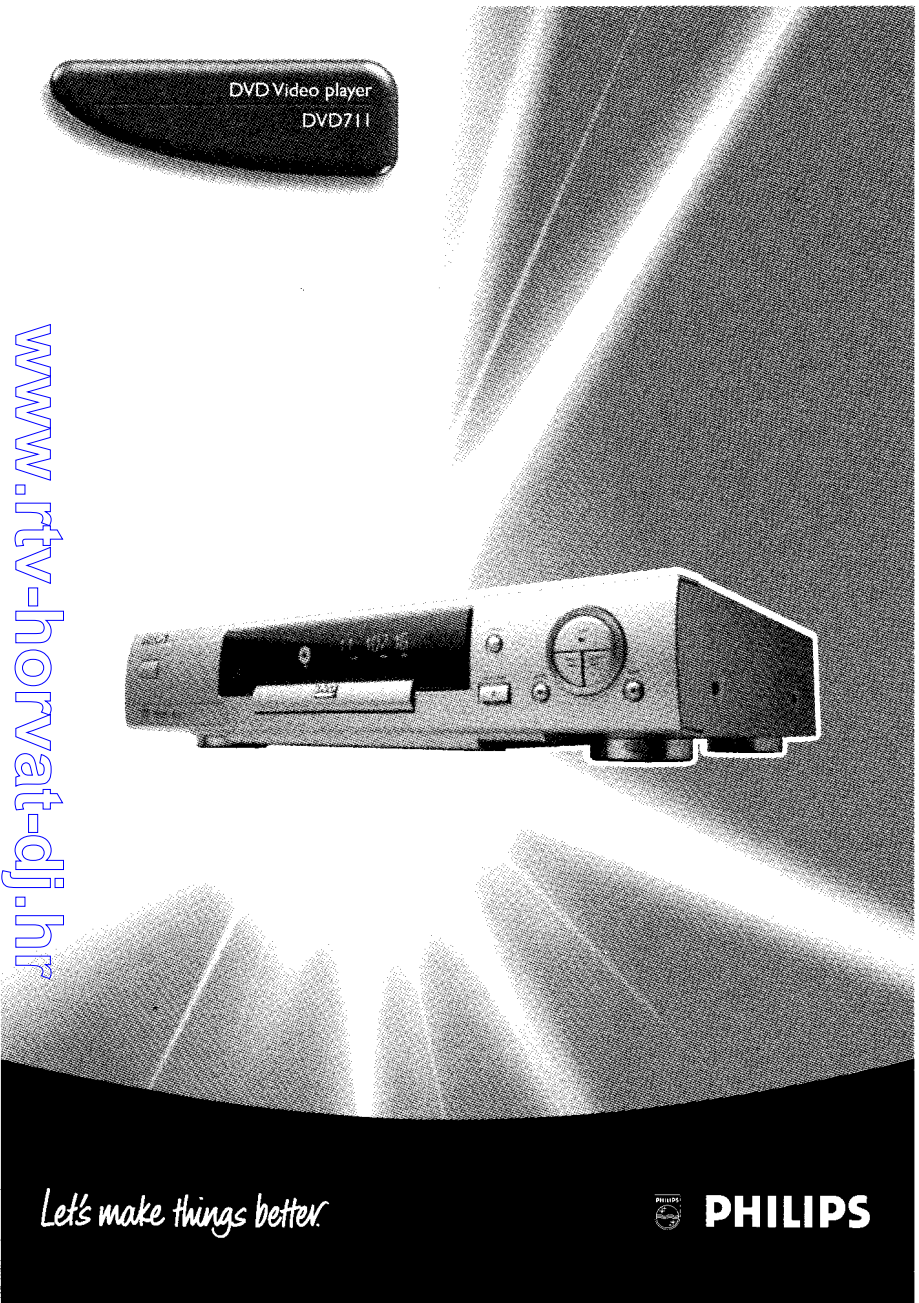

Let's make things better.



**PHILIPS**

www.rtv-horvat-dj.hr

# Index

English ..... 5

Français ..... 36

Español ..... 68

Português ..... 100

www.rtv-horvat-dj.hr

### The region code for this set is 4.



Since it is usual for DVD movies to be released at different times in different regions of the world, all players have region codes and discs can have an optional region code. If you load a disc of a different region code to your player, you will see the region code notice on the screen. The disc will not play, and should be unloaded.

# General information

## Laser safety

This unit employs a laser. Due to possible eye injury, only a qualified service person should remove the cover or attempt to service this device.

**USE OF CONTROLS OR ADJUSTMENTS OR PERFORMANCE OF PROCEDURES OTHER THAN THOSE SPECIFIED HEREIN MAY RESULT IN HAZARDOUS RADIATION EXPOSURE.**

LASER	
Type	Semiconductor laser: GaAlAs
Wave length	650 nm (DVD) 780 nm (VCD/CD)
Output Power	7 mW (DVD) 10 mW (VCD/CD)
Beam divergence	60 degree

*This product incorporates copyright protection technology that is protected by method claims of certain U.S. patents and other intellectual property rights owned by Macrovision Corporation and other rights owners. Use of this copyright protection technology must be authorized by Macrovision Corporation, and is intended for home and other limited viewing uses only unless otherwise authorized by Macrovision Corporation. Reverse engineering or disassembly is prohibited.*

*Manufactured under license from Dolby Laboratories. "Dolby", "AC-3" and the double-D symbol are trademarks of Dolby Laboratories. Confidential Unpublished Works. ©1992-1997 Dolby Laboratories, Inc. All rights reserved.*



**For Customer Use:**

Read carefully the information located at the bottom of your DVD-VIDEO player and enter below the Serial No. Retain this information for future reference.

Model No. DVD-VIDEO \_\_\_\_\_  
Serial No. \_\_\_\_\_

## Contents

<b>Introduction</b>	
Entertainment for the new millennium	6
Introduction	7
Unpacking	7
Placement	7
<b>Functional overview</b>	
Front panel	8
Rear panel	9
Display	10
Remote control	11
<b>On-screen display information</b>	
Menu bar/Status window	12
Status window icons	12
Default screen	12
Temporary feedback field icons	13
<b>Preparation</b>	
General notes	14
Connecting to a TV	14
Connecting to optional equipment	15-16
Connecting to the power cord	16
Remote Control battery installation	16
NTSC/PAL Settings	16
General explanation	17
Turning on the power	18
Initial Setup	18-19
Personal Preferences	19-20
Access Control: child lock	21
Access Control: parental control	22-23
<b>Operation</b>	
Loading discs	24
Playing a DVD-Video disc	24
Playing a Video CD	25
General Features	25-28
Special DVD features	29
Special VCD features	30
Playing an Audio CD	30-31
FTS Program	32
<b>Before requesting service</b>	
Before requesting service	33
Cleaning discs	34
<b>Specifications</b>	
Specifications	35

## Introduction

### Entertainment for the new millennium

Video was never like this before! Digital video discs provide perfect digital, studio-quality pictures; three dimensional digital, multi-channel audio; story sequences screened from your choice of camera angle; sound tracks in as many as eight languages; and up to 32 subtitles (if available on disc). Whether you watch DVD-Video on wide-screen or regular TV, you always see it the way it was meant to be.

### Digital video

DVD-Video uses state-of-the-art MPEG2 data compression technology to register an entire movie on a single 5-inch disc. DVD's variable bitrate compression, running at up to 9.8 Mbits/second, captures even the most complex pictures in their original quality.

The crystal-clear digital pictures have a horizontal resolution of over 500 lines, with 720 pixels (picture elements) to each line. This resolution is more than double that of VHS, superior to Laser Disc, and entirely comparable with digital masters made in recording studios.

DVD-Video discs conform to either the PAL or NTSC video standard. This player can play both PAL and NTSC discs, presenting them in the best possible way on your multi-standard TV screen.

As the universal video system of the future, DVD-Video offers optimal pictures on any TV screen.

### Introduction

Your Philips DVD-Video player will play digital video discs conforming to the universal DVD-Video standard. With it, you will be able to enjoy full-length movies with true cinema picture quality, as well as stereo or multi-channel sound (depending on the disc and your playback setup). The unique features of DVD-Video, such as selection of sound track, subtitle languages and different camera angles (again depending on the disc), are all included. What's more, Philips Child Lock lets you decide which discs your children will be able to see.

In addition to DVD-Video discs, you will be able to play all Video CDs and Audio CDs (including finalized CD Recordable and CD Rewritable). You will find the On-Screen Display, player display, and remote control make the player easy to use. This manual provides all the information you will need, so read on!

### DVD-Video

You will recognize DVD-Video discs by the logo shown on left. Depending on the material on the disc (a movie, video clips, a drama series, etc.) the disc may have one or more Titles. Each Title may have one or more Chapters. To make playback easy and convenient, your player lets you select Titles and playback Chapters.





### Video CD

You will recognize Video CDs by the logo shown at left. Depending on the material on the disc (a movie, video clips, a drama series, etc.) the disc may have one or more tracks. Tracks may have one or more indexes, as indicated on the disc case. To make playback easy and convenient, your player lets you select tracks and indexes.

### Super VCD

SVCD discs based on the Super VCD IO Standard based on the Standard of the Electronics Industry of the People's Republic of China.



### Audio CD

Audio CDs contain music tracks only. You will recognize Audio CDs by their logo which is shown at left. You can play them in conventional style through a stereo system, using the keys on the remote control and/or front panel, or via the TV using the On-Screen Display (OSD).

### Unpacking

First check and identify the contents of your DVD-Video player package. You should have the following items.

- DVD-Video player
- Remote Control with batteries
- AC power cord
- Audio cable
- Video cable
- Instructions for use

If any item is damaged or missing, contact your retailer or Philips.

Keep the packaging materials; you may need them to transport your player in the future.

### Placement

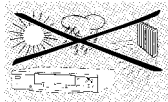

- Place the player on a firm, flat surface.
- Keep the player away from domestic heating equipment and direct sunlight.
- In a cabinet, allow about 2.5 cm (1 inch) of free space all around the player for adequate ventilation.
- If the DVD-Video player cannot read CDs/DVDs correctly, use a commonly available cleaning CD/DVD to clean the lens before taking the DVD-Video player to be repaired. Other cleaning methods may destroy the lens. Always keep the tray closed to avoid dust on the lens.
- The lens may cloud over when the DVD-Video player is suddenly moved from cold to warm surroundings. Playing a CD/DVD is not possible then. Leave the DVD-Video player in a warm environment until the moisture evaporates.

## Functional overview

### Front panel

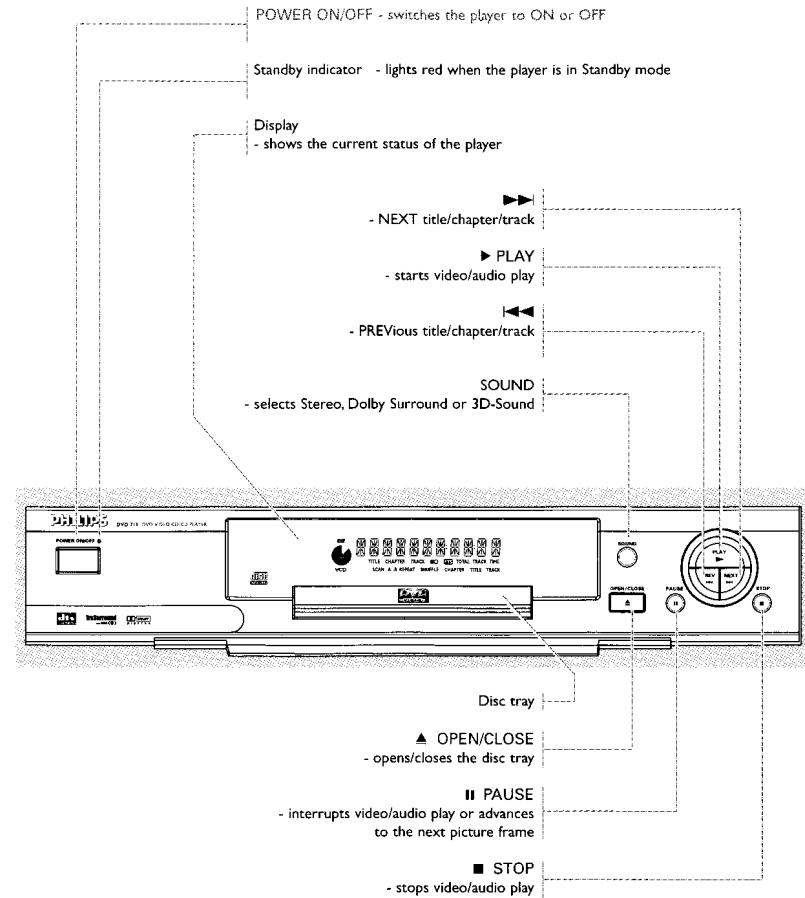



### Rear panel

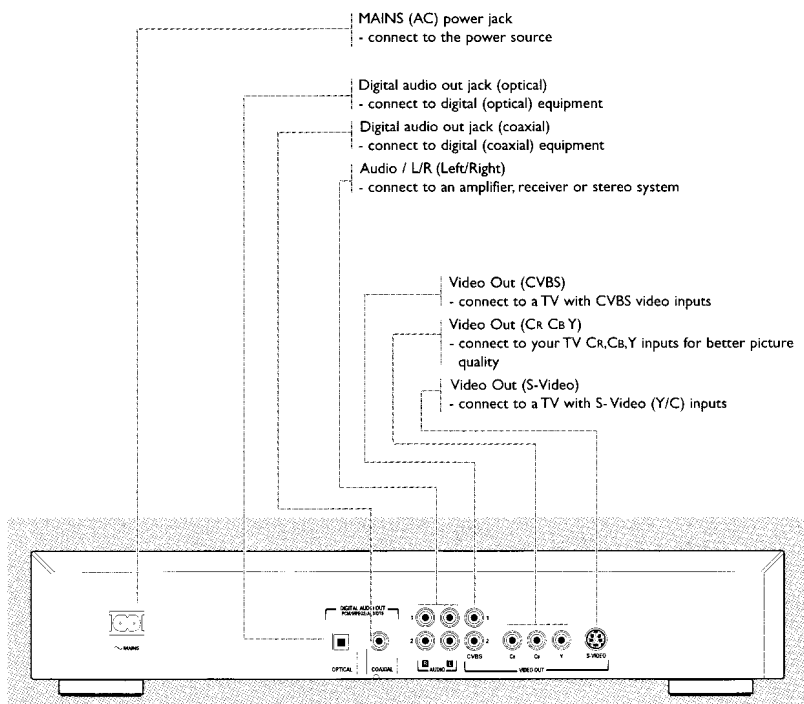

**Caution:** Do not touch the inner pins of the jacks on the rear panel connectors. Electrostatic discharge may cause permanent damage to the unit.

### Display

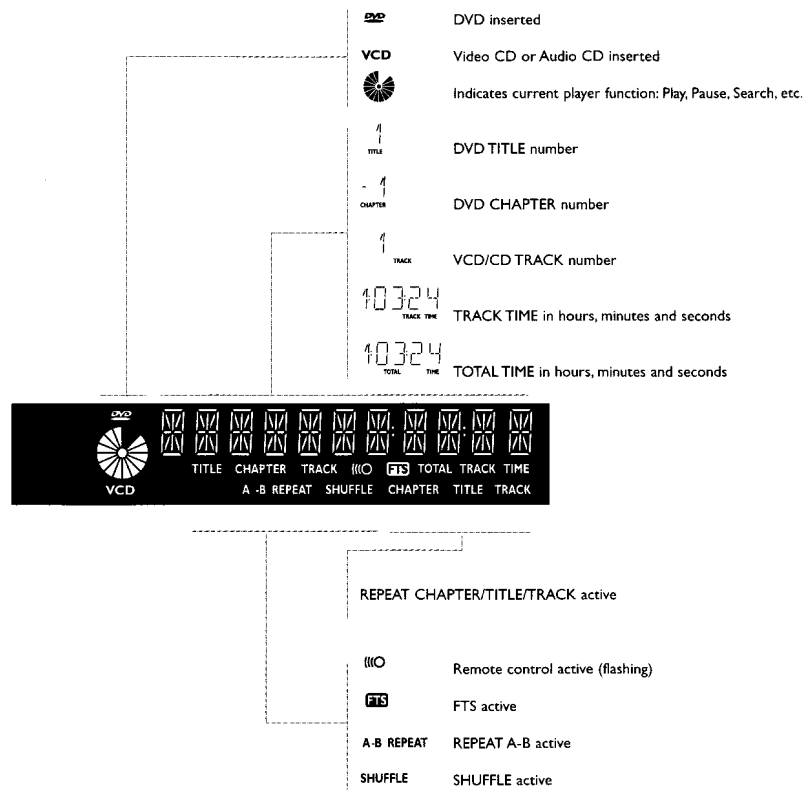

## Remote control

0-9 numerical key pad

### RETURN

- go back to previous menu

### OK

- acknowledge menu selection

◀ ▶ ▲ ▼

- (left/right/up/down) cursor movement

◀◀ ▶▶

- search backward\* / previous chapter or track

■

- stop

▶

- play

▶▶ ▶▶

- search forward\* / next chapter or track

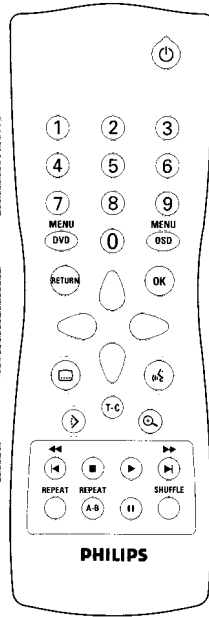

### STANDBY-ON (ON-OFF)

### MENU DVD

- access menu of a DVD

### MENU OSD

- access or remove On-screen display  
- bit rate indicator\*

☰

- subtitle language selector

⏮

- audio language selector

T

- select title

C

- select chapter

⏏

- enlarge video image

▶

- select DVD camera angle

### REPEAT

- repeat chapter, track, title, disc

### REPEAT A-B

- repeat sequence

### SHUFFLE

- playback tracks in random order

⏸

- pause playback temporarily / frame-by-frame playback

## On screen display information

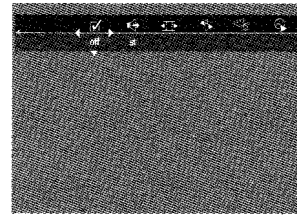
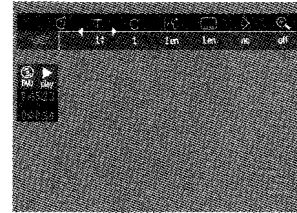

### Menu bar/Status window

- ⚙ Personal Preferences
- T Title/Track
- C Chapter/Index
- 🔊 Audio language
- 🗣 Subtitle language
- 📐 Angle
- 🔍 Zoom
- ☑ Video Program
- 🔊 Sound
- 🖼 Picture by Picture
- ⏪ Slow motion
- ⏩ Fast motion
- 🔍 Time search

### Status window icons

The status window displays the current status of the player and appears with the first part of the menu bar. (You must activate this in the Features Menu - see Personal Preferences for details).

#### General

Disc type

Tray status







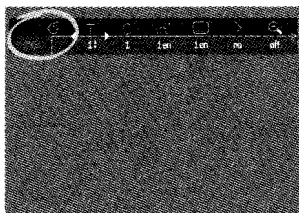





### Default screen

The default screen is displayed when the player is in STOP mode. It may contain a 'Status Window' and a 'Temporary Feedback Field'. This gives information concerning prohibited actions, playback modes, available angles, etc.

\* Press key for about 1 second



**Temporary Feedback Field icons**

-  Repeat All
-  Repeat Title
-  Repeat Track
-  Repeat Chapter
-  Shuffle
-  Shuffle Repeat
-  Repeat A to end
-  Repeat A-B
-  Angle
-  Child Lock On
-  Child Safe
-  Resume
-  Action prohibited

**Preparation**

**General notes**

- Depending on your TV and other equipment you wish to connect, there are various ways you could connect the player. Possible connections are shown in the following drawings. Please refer to the manuals of your TV, VCR, Stereo System or other devices as necessary to make the best connections.
- Do not connect your DVD-player via your VCR. The video quality could be distorted by the copy protection system.
- For better sound reproduction, connect the player's audio out jacks to the audio in jacks of your amplifier, receiver, stereo or A/V equipment. See 'Connecting to optional equipment'.

**Caution: Do not connect the player's audio out jack to the phono in jack of your audio system.**

**Connecting to a TV**

**Component Video (Y Cr Cb) connection**

- 1 Connect the Cr, Cb, Y jacks on the DVD-player to the corresponding jacks on the TV (cable not included) (A).
- 2 Connect the audio Left and Right out jacks to the audio left/right in jacks on the TV (C).

**S-Video (Y/C) connection**

- 1 Connect the S-Video jack on the DVD-player to the S-Video in jack on the TV using an optional S-Video cable (B).
- 2 Connect the audio Left and Right out jacks to the audio left/right in jacks on the TV (C).

**Video CVBS connection**

- 1 Connect the Video out (CVBS) jack to the video in jack on the TV using the video cable supplied (C).
- 2 Connect the audio Left and Right out jacks to the audio left/right in jacks on the TV.

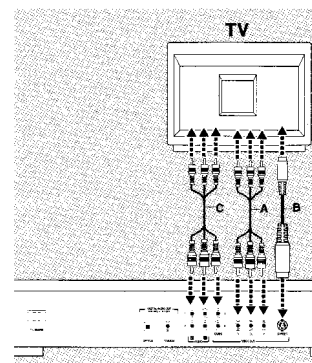

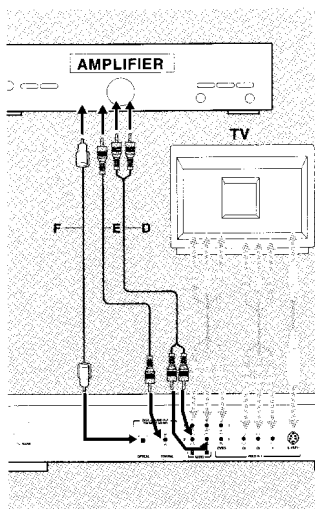

### Connecting to optional equipment

#### Connecting to an amplifier equipped with two channel analog stereo

- Connect the audio Left and Right out jacks of the DVD player to the audio left and right in jack on your amplifier, receiver or stereo system, using the optional audio cable (D).

#### Connecting to an amplifier equipped with two channel digital stereo (PCM)

- 1 Connect the player's digital audio out jack (optical F or coaxial E) to the corresponding in jack on your amplifier. Use an optional digital (optical F or coaxial E) audio cable.
- 2 You will need to activate the player's digital output (see 'Personal Preferences').

#### Connecting to an A/V receiver equipped with a multi-channel decoder (Dolby Digital™ (AC-3), MPEG 2 and DTS)

##### Digital Multi-channel sound

Digital multi-channel connection provides the best sound quality. For this you need a multi-channel A/V receiver that supports one or more of the audio formats supported by your DVD player (MPEG 2, Dolby Digital™ (AC-3) and DTS). Check the receiver manual and the logos on the front of the receiver.

- 1 Connect the DVD player's digital audio output (optical F or coaxial E) to the corresponding input on the receiver using an optional digital (optical F or coaxial E) audio cable.
- 2 You will need to activate the player's digital output (see 'Personal Preferences').

*Note: If the audio format of the digital output does not match the capabilities of your receiver, the receiver will produce a strong, distorted sound or no sound at all. The selected audio format of the DVD is displayed in the Status Window when the Menu OSD is activated or Audio button is activated. Six Channel Digital Surround Sound via digital connection can only be obtained if your receiver is equipped with a Digital Multi-channel decoder. To see the selected audio format of the current DVD in the Status Window, press the MENU OSD or the Audio Language selector button.*

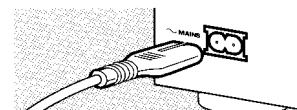
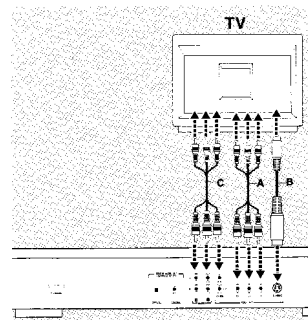
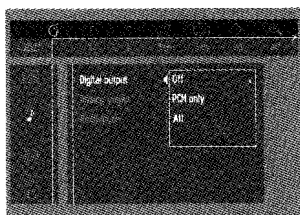

#### Connecting to an amplifier equipped with Dolby Surround™

##### Dolby Surround sound

- 1 Connect the player to the TV, then connect the player's audio Left and Right out jacks to the corresponding in jacks on the Dolby Surround™ Audio/Video receiver, using the audio/video cable supplied (C).

##### If your amplifier is equipped with a Dolby Digital™ decoder,

- Connect the player as described in 'Connecting to an A/V receiver with multi-channel decoder'.

##### If your TV is equipped with a Dolby Surround™ decoder,

- Connect the player to the TV as described in 'Connecting to a TV'.

#### Connecting the power cord

- 1 Plug the female end of the supplied power cord into the Mains (AC) jack on the rear of the player.
- 2 Connect the other end of the cord to an AC outlet.

*Note: When the player is in the "STANDBY" mode, it is still consuming some power. If you wish to disconnect your player completely from the power, unplug the power cord from the AC outlet.*

**Caution: Only qualified service personnel should remove the cover or attempt to service this device.**

#### Remote control battery installation

##### Loading the batteries

- 1 Open the battery compartment cover.
- 2 Insert batteries as indicated inside the battery compartment.
- 3 Close the cover.

**Caution: Do not mix old and new batteries. Never mix different types of batteries (standard, alkaline, etc.)**

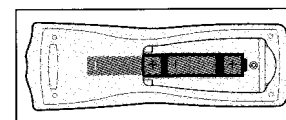

#### NTSC/PAL Settings

You can switch the NTSC/PAL setting of the DVD player to match the video signal of your TV. This setting only affects the television's on-screen display that shows the stop and setup modes. You may select either NTSC or PAL. To change the DVD player setting to PAL or NTSC, follow the steps below.

- 1 Unplug the DVD player from the mains.
- 2 Press and hold **■** and **▶▶|** on the front of the DVD player. While holding **■** and **▶▶|**, plug in the mains.
- 3 After PAL or NTSC appears on the display panel of the DVD player, release **■** and **▶▶|** at the same time. The PAL or NTSC that appears on the display panel indicates the current setting.
- 4 To change the setting, press **▶▶|** within three seconds. The new setting (PAL or NTSC) will appear on the display panel.

## General explanation

### About this manual













This manual gives the basic instructions for operating this DVD player. Some DVDs require specific operation or allow only limited operation during playback. In these cases, the player may not respond to all operating commands. When this occurs, please refer to the instructions contained with the DVD. When the symbol  appears on the TV screen, the operation is not permitted by the player or the disc.

### Remote control operation

- Unless otherwise stated, all operations can be carried out with the remote control. Always point the remote control directly at the player, making sure there are no obstructions in the path of the infrared beam.

When there are corresponding keys on the front panel of the player, they can also be used.

### Menu bar operation

- A number of operations can be carried out via the menu bar on the screen. The menu bar can be accessed by pressing any of the following keys on the remote control: MENU OSD, T-C, Angle, Audio Language, Subtitle Language and Zoom.
- The following functions are available via the menu bar:
  -  Personal Preferences
  -  Title/Track
  -  Chapter/Index
  -  Audio language
  -  Subtitle language
  -  Angle
  -  Zoom
  -  Video Program
  -  Sound
  -  Picture by Picture
  -  Slow motion
  -  Fast motion
  -  Time search
- The various items can be selected by pressing the **MENU OSD** button, then the  $\nabla/\Delta$  keys or by pressing relevant keys on the remote control.
- Pressing **MENU OSD** while the menu bar is displayed will clear the menu bar from the screen.
- When selecting an item in the menu bar, the selected item will be highlighted and the appropriate cursor keys to operate this item will be displayed below the icon.
- < or > indicates that more items are available at the left/right of the menu bar. Press < or > to select these items.

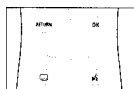

## Turning On the power

- 1 Switch on the TV and select the video input channel for your DVD-Video player.
- 2 Press **POWER ON/OFF** button.



## Initial Setup

### General

In 'Initial Setup' you may have to set your preferences for some of the player's features. (not applicable for all models)

### Operation

After switching on the player for the very first time, the 'Initial Setup Screen' will appear.

The menu for the first item to be set is displayed and the first option is highlighted.

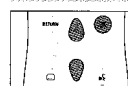
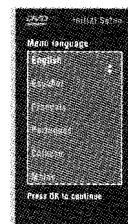

- Use the  $\nabla/\Delta$  keys to go through the options in the menu. The icon of the selected option will be highlighted.
- Use **OK** to confirm your selection and to go to the next menu.

*Note: Preferences have to be set in the order in which the item menus will appear on the screen.*

*The 'Initial Setup' screen will only disappear after the settings for the last item have been confirmed.*

*If any keys other than  $\nabla/\Delta$  or **OK** are pressed,  will appear on the screen.*

*If the player is switched off while setting personal preferences, all preferences have to be set again after switching the player on again.*

### The following items may have to be set in Initial Setup:

#### Menu language

The On Screen Menus will be displayed in the language you choose. You can choose from different languages.

#### Audio language

The sound will be in the language you choose if it is available on the disc in play. If the language you select is not available, speech will revert to the first spoken language on the disc. You can choose from different languages.

#### Subtitle language

The subtitles will be in the language you choose if it is available on the disc in play. If the language you select is not available, subtitles will revert to the first subtitle language on the disc. You can choose from different languages.

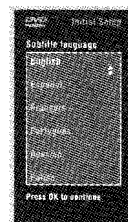

**TV Shape**

If you have a wide screen (16:9) TV, select 16:9.  
 If you have a regular (4:3) TV, select 4:3.  
 If you have a 4:3 TV, you can also select between:  
 Letterbox for a 'wide-screen' picture with black bars top and bottom, or  
 Pan Scan, for a full-height picture with the sides trimmed. If a disc has  
 Pan Scan, the picture then moves (scans) horizontally to keep the main  
 action on the screen.

**Country**





Select your country. This also is used as input for the 'Parental Control'  
 feature (see 'Access Control').

*Note: All these items may have to be set during 'Initial Setup'. After that, they  
 can always be changed in the Personal Preferences Menu.*

**Personal Preferences**

You can set your personal preferences for some of the player features.

**General operation:**

- Press **MENU OSD** on the remote control.
- Select  in the menu bar.  
 > The Personal Preferences menu appears.
- Use the     keys to toggle through the menus, submenus and submenu options.  
 > When a menu item is selected, the cursor keys (on the remote control) to operate the item are displayed next to the item.
- Press **OK** to confirm and return to the main menu.

The following items can be adapted:

**Picture**

- **TV Shape**  
 See 'Initial Setup'
- **Black level shift (NTSC only)**  
 Select ON for adapting the color dynamics to obtain richer contrasts.

- **Video shift**

The factory centers the video on your screen. Use this setting to  
 personalize the position of the picture on your TV by scrolling it to the  
 left or right.

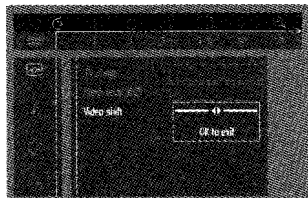
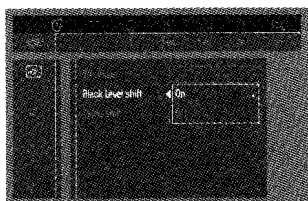
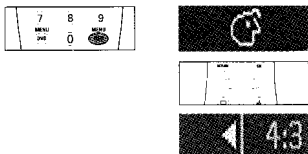

**Sound**

- **Digital output**  
 Factory setting: ALL. This means that both coaxial and optical outputs  
 are switched on. If you are not connecting equipment with a digital  
 input, change the setting to OFF.  
 If your equipment doesn't include a digital multi-channel decoder, set  
 the digital output to PCM (Pulse Code Modulation). Both coaxial and  
 optical outputs are switched on.
- **Analog output**  
 Select Stereo, Dolby Surround or 3D sound.
- **Night Mode**  
 Optimizes the dynamics of the sound with low volume playback.
- **Karaoke vocal**  
 Put this setting to ON only when a multi-channel karaoke DVD is  
 being played. The karaoke channels on the disc will then be mixed to a  
 normal stereo sound.

**Language**

Select the required Menu, Audio and Subtitle language. See 'Initial Setup'.  
 Audio language and Subtitle language can also be adapted via the Menu  
 bar on the screen.

**Features**

- **Access Control**  
 Access Control contains the following features:  
 Child Lock - When Child Lock is set to ON, a 4-digit code needs to be  
 entered in order to play discs.  
 Parental control - Allows the conditional presentation of DVDs  
 containing Parental Control information (see 'Access Control').
- **Status Window**  
 Displays the current status of the player and is displayed with the menu  
 bar. When disc playback is stopped, it is displayed with the 'Temporary  
 Feedback Field' in the default screen. See 'On-Screen Display  
 information'.  
 Factory setting is ON. Select OFF to suppress display of the Status  
 Window.
- **Bit Rate Indicator**  
 When activated, the bit rate for video, audio as well as total bit rate is  
 displayed. This is only applicable during playback of DVD & SVCD discs.

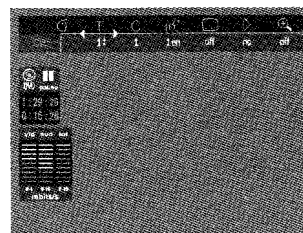
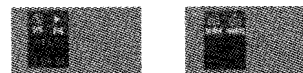

## Access control; child lock (DVD and VCD)

### Activating/deactivating the child lock

- 1 When disc playback is stopped, select **ACCESS CONTROL** in the features menu using the  $\nabla/\Delta$  keys.
- 2 Enter a 4-digit code of your own choice.
- 3 Enter the code a second time.
- 4 Move to "Child Lock" using the  $\nabla/\Delta$  keys.
- 5 Move to LOCK/UNLOCK using the  $\triangleright$  key.
- 6 Select LOCK using the  $\nabla/\Delta$  keys.
- 7 Press **OK** or  $\triangleleft$  to confirm, then press  $\triangleleft$  again to exit the menu.
  - Now unauthorized discs will not be played unless the 4-digit code is entered.
- 8 Select UNLOCK to deactivate the Child Lock.

Note: Confirmation of the 4-digit code is necessary when:

- The code is entered for the very first time (see above),
- The code is changed (see 'Changing the 4-digit code'),
- The code is cancelled (see 'Changing the 4-digit code').

### Authorizing discs

- Insert the disc. See 'Loading disc'.
  - The 'child protect' dialog will appear. You will be asked to enter your secret code for 'Play Once' or 'Play Always'. If you select 'Play Once', the disc can be played as long as it is in the player and the player is ON. If you select 'Play Always', the disc will become child safe (authorized) and can always be played, even if the Child Lock is set to ON.

Notes: The player memory maintains a list of 50 authorized ('Child safe') disc titles. A disc will be placed in the list when 'Play Always' is selected in the 'child protect' dialog. Each time a 'child safe' disc is played, it will be placed on top of the list. When the list is full and a new disc is added, the last disc in the list will be removed from the list.

Double sided DVDs may have a different ID for each side. In order to make the disc 'child safe', each side has to be authorized.

Multi-volume VCDs may have a different ID for each volume. In order to make the complete set 'child safe', each volume has to be authorized.

### Deauthorizing discs

- Insert the disc. See 'Loading disc'.
  - Playback starts automatically.
- Press  $\blacksquare$  while  $\odot$  is visible.
  - The  $\odot$  will appear and the disc is now deauthorized.

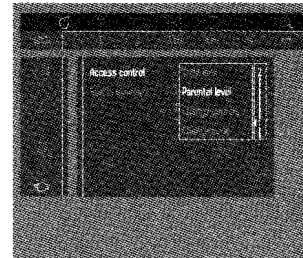
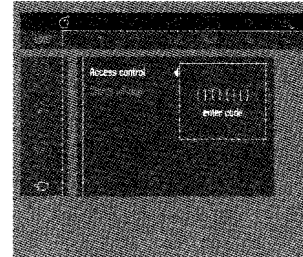
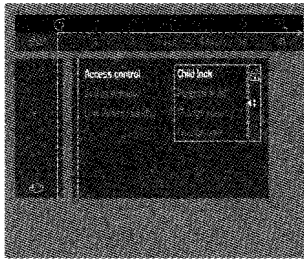

## Access control; Parental control (DVD-Video only)

Movies on DVDs may contain scenes not suitable for children. Therefore, disc may contain 'Parental Control' information which applies to the complete disc or to certain scenes on the disc. These scenes are rated from 1 to 8, and alternative, more suitable scenes are available on the disc. Ratings are country dependent. The 'Parental Control' feature allows you to prevent discs from being played by your children or to have certain discs played with alternative scenes.

### Activating/Deactivating Parental Control

- 1 When disc playback is stopped, select **ACCESS CONTROL** in the features menu using the  $\nabla/\Delta$  keys.
- 2 Enter your 4-digit code. If necessary, enter the code a second time.
- 3 Move to Parental Control using the  $\nabla/\Delta$  keys.
- 4 Move to **VALUE ADJUSTMENT** (1-8) using the  $\triangleright$  key.
- 5 Then use the  $\nabla/\Delta$  keys or the numerical keys on the remote control to select a rating from 1 to 8 for the disc inserted.

Rating 0 (displayed as '- - -'): Parental Control is not activated. The Disc will be played in full.

Ratings 1 to 8:

The disc contains scenes not suitable for children. If you set a rating for the player, all scenes with the same rating or lower will be played. Higher rated scenes will not be played unless an alternative is available on the disc. The alternative must have the same rating or a lower one. If no suitable alternative is found, play will stop and the 4-digit code has to be entered.

- 6 Press **OK** or  $\triangleleft$  to confirm, then press  $\triangleleft$  again to exit the menu.

### Country

- 1 When disc playback is stopped, select **ACCESS CONTROL** in the features menu using the  $\nabla/\Delta$  keys.
- 2 Enter the 4-digit code.
- 3 Move to **CHANGE COUNTRY** using the  $\nabla$  key.
- 4 Press the  $\triangleright$  key.
- 5 Select a country using  $\nabla/\Delta$ .
- 6 Press **OK** or  $\triangleleft$  to confirm, then press  $\triangleleft$  again to exit the menu.

### Changing the 4-digit code

- 1 When disc playback is stopped, select **ACCESS CONTROL** in the features menu using the  $\nabla/\Delta$  keys.
- 2 Enter the old code.
- 3 Move to **CHANGE CODE** using the  $\nabla$  key.
- 4 Press the  $\triangleright$  key.
- 5 Enter the new 4-digit code.
- 6 Enter the code a second time and reconfirm by pressing **OK**.
- 7 Press  $\triangleleft$  to exit the menu.

*Note: If you forget your 4 digit code, it can be cancelled by pressing **■** four times in the 'Access Control' dialog. You can then enter a new code (twice!) as described above.*

### Parental Control Disclaimer

This DVD player features the PARENTAL CONTROL system which is intended to activate when playing DVD discs furnished with certain software coding. This is according to technical standards adopted by the set maker and disc content industries.

Please note that the PARENTAL CONTROL system will not operate a DVD disc which is not furnished with the appropriate software coding. Also note that at the time of release of this DVD player, certain aspects of the technical standards had not been settled between set makers and the disc industries.

On this basis Philips cannot guarantee functioning of the PARENTAL CONTROL system and denies any liability associated with unintended watching of disc content.

If in doubt, please make sure the disc plays according to your PARENTAL CONTROL settings before you allow children access.

## Operation

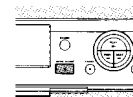

### Loading discs

- 1 Press **OPEN/CLOSE** on the front of the player. The disc tray opens.
- 2 Load your chosen disc in the tray, label side up (also when a double sided DVD is inserted). Make sure it is sitting properly in the correct recess.
- 3 Press **OPEN/CLOSE**, to close the tray.

► **READY** appears in the status window and on the player display, and playback starts automatically.

*Note: If 'Child Lock' is set to ON and the disc inserted is not in the 'child safe' list (not authorized), the 4-digit code must be entered and/or the disc must be authorized (see 'Access Control').*

### Playing a DVD-video disc

#### Playing a title

► After inserting the disc and closing the tray, playback starts automatically and the status window and the player display show the type of disc loaded, as well as information about the disc's contents and playing time.

The disc may invite you to select an item from a menu. If the selections are numbered, press the appropriate numerical key; if not, use the  $\nabla/\Delta$ ,  $\triangleleft/\triangleright$  keys to highlight your selection, then press **OK**.

► The currently playing title and chapter number are displayed in the menu bar and the player display.

The elapsed playing time is shown in the status window and the player display.

- If required, you can use the **Sound** key to select Stereo, Dolby Surround or 3D-Sound. Play may stop at the end of the Title, and the player may return to the DVD menu. To go on to the next title, press  $\triangleright$ .
- To stop play at any other time, press **■**.
  - The default screen will appear, giving information about the current status of the player.
- You can resume play from the point at which you stopped play. Press  $\triangleright$ ; when you see the Resume icon  $\blacktriangleright$  on the screen, press  $\triangleright$  again.
  - The RESUME feature applies not only to the disc in the player, but also to the last four discs you have played. Simply reload the disc, and press  $\triangleright$ ; when you see the Resume icon  $\blacktriangleright$  on the screen, press  $\triangleright$  again.

*Note: Since it is usual for DVD movies to be released at different times in different regions of the world, all players have region codes. Discs can have an optional region code. If you load a disc of a different region code into your player, you will see the region code notice on the screen. The disc will not play and should be removed from the player.*





## Playing a Video CD

### Playing a disc

- After inserting the disc and closing the tray, playback starts automatically and the status window and the player display show the type of disc loaded, as well as information about the disc's contents and playing time.
- The disc may invite you to select an item from a menu. If the selections are numbered, press the appropriate numerical key.
- The currently playing track number is displayed in the menu bar and the player display. The elapsed playing time is shown in the status window and the player display.
- If required, you can use the **SOUND** key to select Stereo, Dolby Surround or 3D-Sound.
- To stop play at any time, press ■.
- The default screen will then appear.
- You can resume play from the point at which you stopped play. Press ►; when you see the Resume icon on the screen ►, press ► again. The RESUME feature applies not only to the disc in the player, but also to the last four discs you have played. Simply reload the disc, and press ►; when you see the Resume icon ► on the screen, press ► again.

### General features

*Note: Unless stated otherwise, all operations described are based on remote control operation. A number of operations can also be carried out via the menu bar on the screen. (see 'Menu bar operation')*

### Moving to another title/track

When a disc has more than one title or track (which you can see from both the menu bar and the player display), you can move to another title as follows:

- Press T-C (title/chapter), then press ►| briefly during play to select the next title/track.
- Press T-C (title/chapter), then press |◀ briefly during play to return to the beginning of the current title/track. Press |◀ twice briefly to step back to the previous title/track.

### Moving to another chapter/index

When a title on a disc has more than one chapter or a track has more than one index (which you can see from the player display and on the menu bar), you can move to another chapter/index as follows:

- Press ►| briefly during play to select the next chapter/index.
- Press |◀ briefly during play to return to the beginning of the current chapter/index. Press |◀ twice briefly to step back to the previous chapter/index.
- To go directly to any chapter or index, select T-C (title/chapter), then enter the chapter/index number using the numerical keys (0-9).

*Note: If the number has more than one digit, press the keys in rapid succession.*

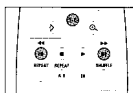
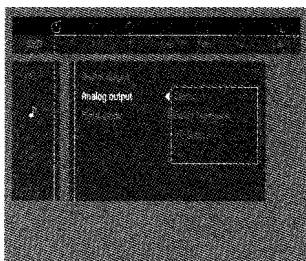

## Still Picture and Frame-by-frame playback



- Select ◀| (picture by picture) in the menu bar.
- Use the ▾ key to enter the picture by picture menu.
  - The player will now go into PAUSE mode.
- Use the cursor keys ◀ ▶ to select the previous or next picture frame.
- To exit Picture by picture mode, press ► or △.

You can also step forward by pressing II repeatedly on the remote control.

### Search

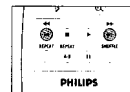

- Select ⏮ (Fast motion) in the menu bar.
- Use the ▾ keys to enter the Fast Motion menu.
- Use the ◀ ▶ keys to select the required speed: -32, -8 or -4 (backward), or +4, +8, +32 (forward).
- Select 1 to play at normal speed again.
- To exit Fast Motion mode, press ► or △.

To search forward or backward through different speeds, you can also hold down ◀◀ or ▶▶.

### Repeat

#### DVD-Video Discs - Repeat chapter/title/disc

- To repeat the currently playing chapter, press **REPEAT**.
  - **REPEAT CHAPTER** appears on the player display.
- To repeat the title currently playing, press **REPEAT** a second time.
  - **REPEAT TITLE** appears on the display.
- To repeat the entire disc, press **REPEAT** a third time.
  - **REPEAT** appears on the display.
- To exit Repeat mode, press **REPEAT** a fourth time.

#### Video CDs - Repeat track/disc

- To repeat the track currently playing, press **REPEAT**.
  - **REPEAT TRACK** appears on the player display.
- To repeat the entire disc, press **REPEAT** a second time.
  - **REPEAT** appears on display and screen.
- To exit Repeat mode, press **REPEAT** a third time.

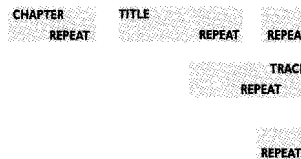

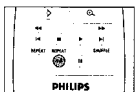

### Repeat A-B

- To repeat a sequence in a title:
- Press **REPEAT A-B** at your chosen starting point;
    - **A-** appears briefly on the screen.
  - Press **REPEAT A-B** again at your chosen end point;
    - **A-B REPEAT** appears briefly on the display, and the repeat sequence begins. (**A-B REPEAT** is displayed on the front panel of the player)
  - To exit the sequence, press **REPEAT A-B**.

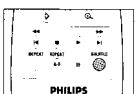

### Shuffle

#### DVD-Video discs

- This shuffles the playing order of chapters within a title, if the title has more than one.
- Press **SHUFFLE** during play.
    - **SHUFFLE** appears on the screen for about 2 seconds.
  - To return to normal play, press **SHUFFLE** again.

#### Video CDs

- This shuffles the playing order of the tracks, if the disc has more than one.
- Press **SHUFFLE** during play.
    - **SHUFFLE** appears on the screen for about 2 seconds.
  - To return to normal play, press **SHUFFLE** again.

### Time search

The Time Search function allows you to start playing at any chosen time on the disc.

- Select **Time Search** in the menu bar.
- Press **▽**.
  - The player will now go into **PAUSE** mode.
  - A time edit box appears on the screen, showing the elapsed playing time of the current disc.
- Use the digit keys to enter the required start time. Enter hours, minutes and seconds from left to right in the box.
  - Each time an item has been entered, the next item will be highlighted.
- Press **OK** to confirm the start time.
  - The time edit box will disappear and play starts from the selected time position on the disc.

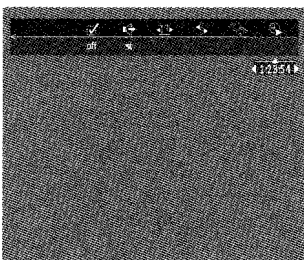

### Zoom

The Zoom function allows you to enlarge the video image and to pan through the enlarged image.

- Select **Zoom** in the menu bar.
- Press **▽/△** to activate the **ZOOM** function and select the required zoom factor: 1.33 or 2 or 4.
  - The player will go into Pause mode.
  - The selected zoom factor appears below the **Zoom** icon in the menu bar and 'Press OK to pan' appears below the menu bar.

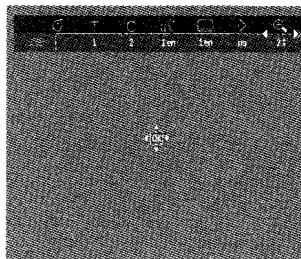
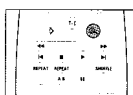

- The picture will change accordingly.
- Press **OK** to confirm the selection.
  - The panning icons appear on the screen: **△ ▽ ◀ ▶** and **OK**.
- Use the **△ ▽ ◀ ▶** keys to pan across the screen.
- When **OK** is pressed only the zoomed picture will be shown on the screen.
- If you wish to zoom at any moment, press **Zoom** and select the required zoom factor as described above.
- To exit **Zoom** mode:
  - Press **▶**.
  - Playback will resume.
  - Press **STOP, MENU OSD**.

### FTS-Video

- The **FTS-Video** function allows you to store your favorite titles and chapters (DVD) and favorite tracks and indexes (VCD) for a particular disc in the player memory.
- Each **FTS** program can contain 20 items (titles, chapters).
- Each time an **FTS** program is played it will be placed on top of the list. When the list is full and a new program is added, the last program in the list will be removed from the list.
- The selections can be called up and played at any time.

#### Storing a FTS-Video Program

- In **STOP** mode, select **Video FTS** **✓** in the menu bar.
- Press **▽** to open the menu.
  - The **Video FTS** menu appears.
- Press **<** or **>** or **FTS** to select **ON** or **OFF**.

#### Storing titles/tracks

- Press **▽** to select **TITLES**.
- Use **>** and **<** to select the required title.
- Press **OK** if you wish to store the entire title.
  - The title number will be added to the list of selections.

#### Storing chapters/indexes

- Press **▽** on the selected title number.
  - The title number will be marked and the highlight moves to the first available chapter number for this title.
- Use **>** and **<** to select the required chapter number.
- Press **OK** to confirm the selection.
  - The title/chapter selection will be added to the list of selections.
- Press **MENU OSD** to exit the **Video FTS** **✓** menu.

#### Erasing a FTS-Video Program

- In **STOP** mode, select **Video FTS** **✓** in the menu bar.
- Use **▽** to select **PROGRAM**.
- Use **>** and **<** to select the required selection number.
- Press **OK** to erase the selection.
- Press **MENU OSD** to exit.

#### If you wish to erase all selections:

- In **STOP** mode, select **Video FTS** **✓** in the menu bar.
- Use **▽** to select **CLEAR ALL**.
- Press **OK**.
  - All selections will now be erased.
- Press **MENU OSD** to exit.

## Special DVD-features

### Checking the contents of DVD-Video discs: Menus

For titles and chapters, selection menus may be included on the disc. The DVD's menu feature allows you to make selections from these menus. Press the appropriate numerical key; or use the  $\nabla$ ,  $\Delta$ ,  $\triangleright$ ,  $\triangleleft$  keys to highlight your selection, then press **OK**.

### Title menus

- Press **MENU DVD**.
  - ▶ If the current title has a menu, the menu will appear on the screen. If no menu is present in the title, the disc menu will be displayed.
- The menu can list camera angles, spoken language and subtitle options, and chapters for the title.
- To remove the title menu, press **MENU DVD** again.

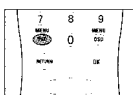

### Disc menu

- Press **T-C** then press **MENU DVD**.
  - ▶ The disc menu is displayed.
- To remove the disc menu, press **T-C**, then press **MENU DVD**.

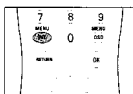

### Camera Angle $\triangleright$

If the disc contains sequences recorded from different camera angles, the angle icon appears, showing the number of available angles and the angle being shown currently. You can then change the camera angle if you wish.

- Use the  $\nabla/\Delta$  keys to select the required angle in the angle icon.
  - ▶ After a small delay, play changes to the selected angle. The angle icon remains displayed until multiple angles are no longer available.



### Changing the audio language

- Select **Audio** in the menu bar.
- Press **Audio** or  $\nabla/\Delta$  repeatedly to see the different languages.



### Subtitles

- Select **Subtitle** in the menu bar.
- Press **Subtitle** or  $\nabla/\Delta$  repeatedly to see the different subtitles.



## Special VCD-Features

### Playback Control (PBC)

- Load a Video CD with PBC and press  $\triangleright$ .
- Go through the menu with the keys indicated on the TV screen until your chosen passage starts to play. If a PBC menu consists of a list of titles, you can select a title directly.
- Enter your choice with the numerical keys **(0-9)**.
- Press **RETURN** to go back to the previous menu.
- You may also set the PBC OFF under Personal Preferences menu.

### Playing an audio CD

- After loading the disc, playback starts automatically.
- If the TV is on, the Audio CD screen appears.
- The number of tracks and the total playing time will be shown on the screen.
- During play, the current track number and its elapsed playing time will be shown on the screen and on the player display.
- Playback will stop at the end of the disc.
- To stop play at any other time, press  $\blacksquare$ .

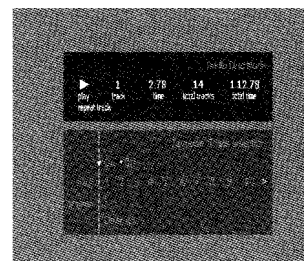

### Pause

- Press **II** during play.
- To return to play, press  $\triangleright$ .

### Search

- To search forward or backward through the disc at four times normal speed, hold down  $\triangleleft$  or  $\triangleright$  for about one second during play.
  - ▶ Search begins, and sound is partially muted.
- To step up to eight times the normal speed, press  $\triangleleft$  or  $\triangleright$  again.
  - ▶ Search goes to eight times the speed, and the sound is muted.
- To return to four times the normal speed, press  $\triangleleft$  or  $\triangleright$  again.
- If the TV is on, search speed and direction are indicated on the screen each time  $\triangleleft$  or  $\triangleright$  is pressed.
- To end the search, press  $\triangleright$  to resume playback or  $\blacksquare$  to stop.

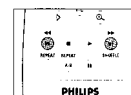
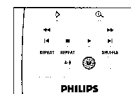

### Moving to another track

- Press  $\triangleright$  briefly during play to go to the next track.
- Press  $\triangleleft$  briefly during play to return to the beginning of the current track. Press  $\triangleleft$  twice briefly to step back to the previous track.
- To go directly to any track, enter the track number using the numerical keys **(0-9)**.

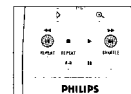

### Shuffle

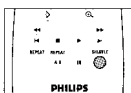

- Press **SHUFFLE** during play.
  - The order of the tracks is changed.
- To return to normal play, press **SHUFFLE** again.

### Repeat track/disc

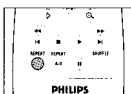

- To repeat the track currently playing, press **REPEAT**.
  - **REPEAT TRACK** appears on the display.
- To repeat the entire disc, press **REPEAT** a second time.
  - **REPEAT** appears on the display.
- To exit Repeat mode, press **REPEAT** a third time.

### Repeat A-B

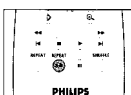

- To repeat a sequence:
- Press **REPEAT A-B** at your chosen starting point;
    - **A-** appears on the player display.
  - Press **REPEAT A-B** again at your chosen end point;
    - **A-B** appears on the display, and the sequence begins to play repeatedly.
  - To exit the sequence, press **REPEAT A-B** again.



## FTS Program

- FTS Program allows you to store your favorite tracks for a particular disc in the player memory.
- Each FTS Program can contain 20 tracks.

### Storing an FTS Program

- 1 Load a disc and stop playback.
- 2 Use  $\nabla$  to go to the list of available tracks.
- 3 Use  $\triangleleft$  or  $\triangleright$  to select tracks from the list. To go directly to any track, enter the track number using the numerical keys (0-9).
- 4 Store each track by pressing **OK**.
  - The track numbers will be added to the list of selected tracks.
  - The number of tracks and the playing time of the program will be shown on the screen and the player display.

When your FTS Program is complete, press  $\blacktriangleright$  to start play, or  $\triangle$  to go back to Stop mode. In either case, the FTS Program will be automatically memorized.

### Switching FTS ON/OFF

- 1 Use  $\triangle$   $\nabla$  to move to the top.
- 2 Use  $\triangleleft$  or  $\triangleright$  to select either ON or OFF.

### Erasing a track from an FTS Program

- 1 Use  $\nabla$  to go to the list of selected tracks.
- 2 Use  $\triangleleft$  and  $\triangleright$  to select the track number you wish to erase.
- 3 Press **OK**.
  - The track number will be erased from the list of selected tracks.

### Erasing the complete program

- Use  $\nabla$  to select Clear All, then press **OK**.
  - The complete FTS Program for the disc will be erased.

## Before requesting service

If it appears that the DVD-Video player is faulty, first consult this checklist. It may be that something has been overlooked. Under no circumstances attempt to repair the system yourself; this will invalidate the warranty.

Look for the specific symptom(s). Then perform only the actions listed to remedy the specific symptom(s).

Symptom	Remedy
<b>No power</b>	Make sure the mains cord (AC) is properly connected. Check if there is power at the AC outlet by plugging in another appliance.
<b>No picture</b>	Check if the TV is switched on. Check the video connection.
<b>Distorted picture</b>	Check the disc for fingerprints and clean with a soft cloth, wiping from center to edge. Sometimes a small amount of picture distortion may appear. This is not a malfunction.
<b>Completely distorted picture or no color with player menu.</b>	If the picture is distorted completely or if the picture rolls vertically, make sure the NTSC/PAL setting at the DVD player matches the video signal of your television. If your TV video signal is NTSC, select the NTSC setting at the DVD player. If your video signal is PAL, select the PAL setting - see <b>NTSC/PAL SETTINGS</b> .
<b>Distorted or Black/White picture with DVD or Video CD.</b>	The disc format does not match your TV's video signal (PAL/NTSC).
<b>No sound</b>	Check audio connections. If you are using a HiFi amplifier, try another sound source.
<b>Distorted sound from HiFi amplifier.</b>	Check to make sure that no audio connections are made to the amplifier phono input.
<b>No audio at digital output.</b>	Check the digital connections. Check the settings menu to make sure the digital output is set to ALL or PCM. Check if the audio format of the selected audio language matches your receiver capabilities.
<b>Disc can't be played.</b>	Ensure the disc label is facing up. Clean the disc. Check if the disc is defective by trying another disc. Check to see if the disc is defective, badly scratched or warped (not flat)
<b>No return to start-up screen when disc is removed.</b>	Reset by switching the player off, then on again. Check to see if the program requires another disc to be loaded.
<b>The player does not respond to the remote control.</b>	Aim the remote control directly at the sensor on the front of the player. Remove any obstacles between the player and the remote control. Inspect or replace the batteries in the remote control.
<b>Buttons do not work.</b>	In order to completely reset the player, unplug the AC cord from the AC outlet for a few seconds.
<b>Player does not respond to all operating commands during playback.</b>	Operations are not permitted by the disc. Refer to the instructions of the disc.
<b>DVD-Video player cannot read CDs/DVDs correctly</b>	Use a commonly available cleaning CD/DVD to clean the lens before taking the DVD-Video player to be repaired

## Cleaning discs

Some problems occur because the disc inside the player is dirty. To avoid these problems clean your discs regularly, in the following way:

- When a disc becomes dirty, clean it with a cleaning cloth. Wipe the disc from the center out.



**Caution:** Do not use solvents such as benzine, thinner, commercially available cleaners, or anti-static spray intended for analog discs.

## 4. Service hints

### 4.1 DVD-Module 218

The DVD mechanism has to be exchanged completely in case of failure. A new or repaired mechanism can be ordered with codenumber 9305 023 61001.

Return the defective unit complete assembled in original package to Philips Consumer Service in Eindhoven.

The monoboard has to be repaired on component level.

### 4.3 Power Supply options

3122 427 21750		3122 427 21370		3122 427 21760	
110V USA		220V Europe China		Multi voltage A/P	
2261	CAP 330pF	2121	ELCO 100uF 385V	2261	CAP 330pF
2121	ELCO 150uF 250V			2121	ELCO 150uF 400V
3133	Resistor 10M				

### 4.4 Compair

For assistance with the repair process of the monoboard an electronic Fault finding guidance has been developed , this program is called COMPAIR.

This COMPAIR program is available on CDROM.

The Version of the CDROM for repair of the monoboard is V1.3 and can be ordered with codenumber : 4822 727 21637.

This is an update CDROM , so when the COMPAIR CDROM is used for the first time , one has to install the COMPAIR ENGINE CDROM V1.2 first.

The V1.2 CDROM can be ordered with codenumber 4822 727 634 and has to registered after installation , the procedure for registration is explained in the help file of the program and in the booklet from the CDROM.

The cable to connect the monoboard with a PC can be ordered with codenumber 3122 785 90017.

All the hardware and software requirements of the systems necessary for working with COMPAIR is described on the CDROM.

### 4.5 Monoboard repair

For repair of the monoboard the service manual 3122 785 10045 must be used.

### 4.2 Diagnostic software

In chapter "Diagnostic software" some tests are referring to the SCART functionality.

These tests are for sets with RGB-output.

For sets without RGB-output no SCART connector is mounted. In these sets the SCART tests will automatically be skipped

## 5. Block and wiring diagram, dismantling, exploded view and oscillograms

### Blockdiagram

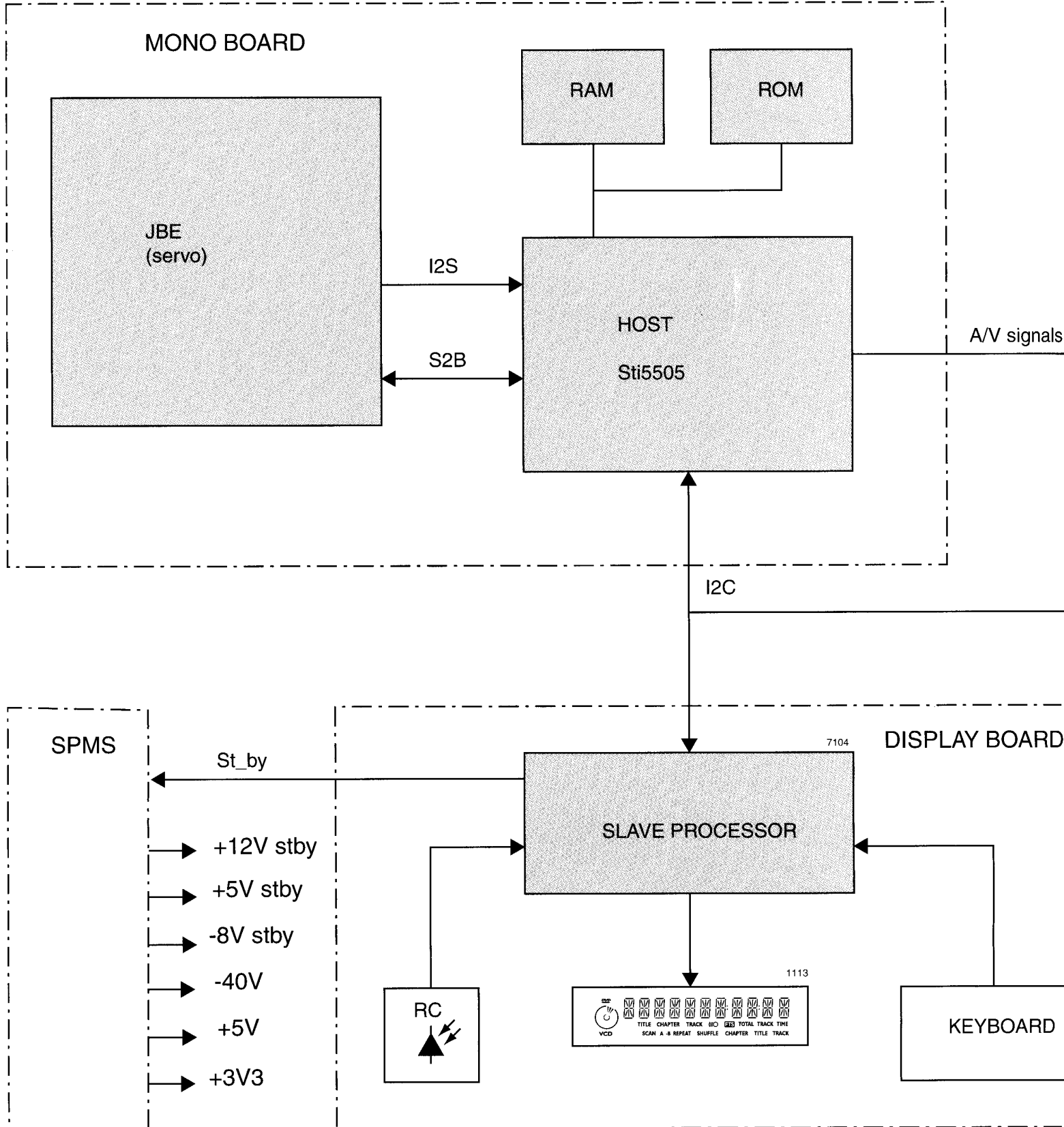

view and

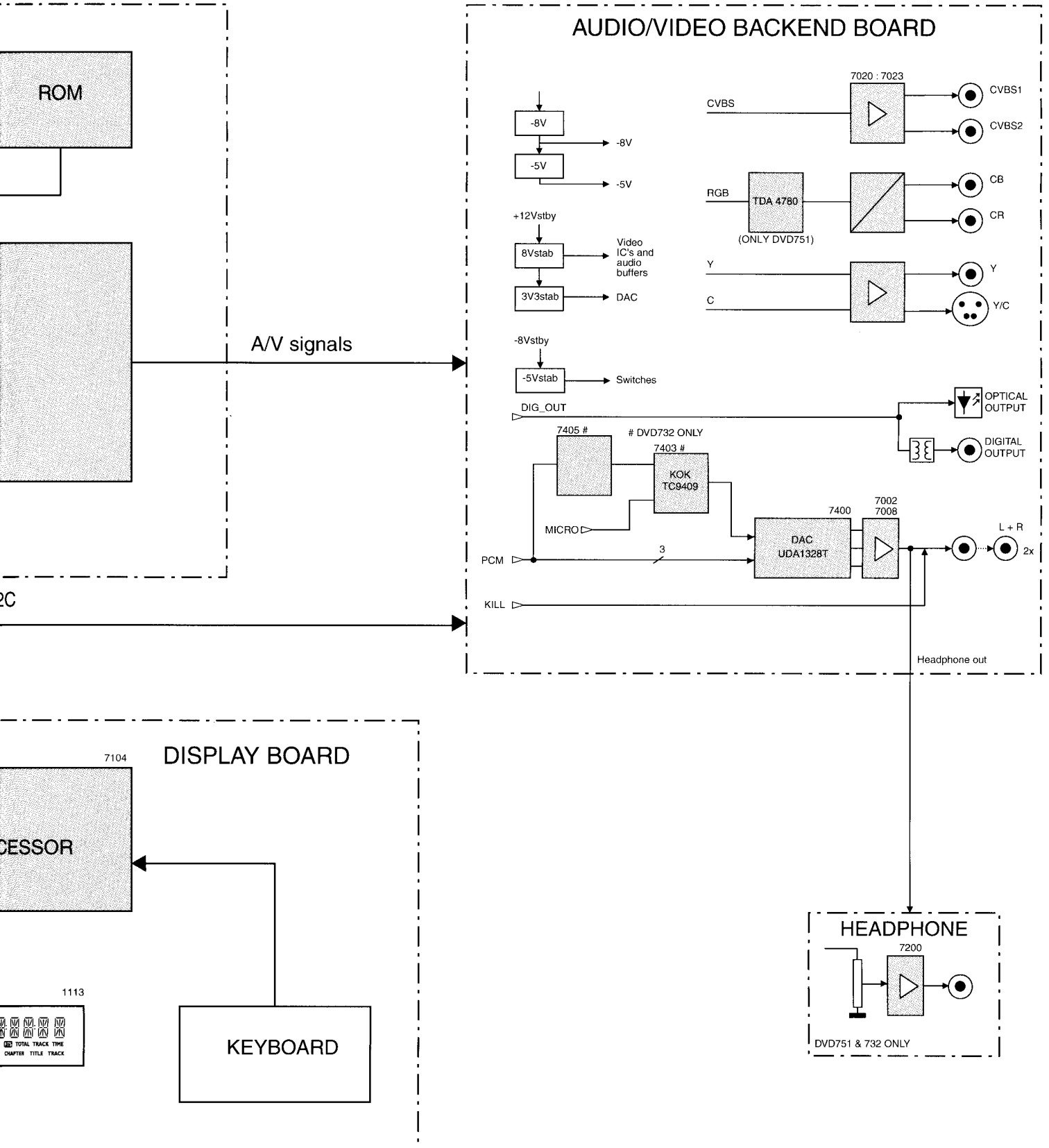



### Dismantling instructions

#### DISMANTLING INSTRUCTIONS

See exploded view for item numbers

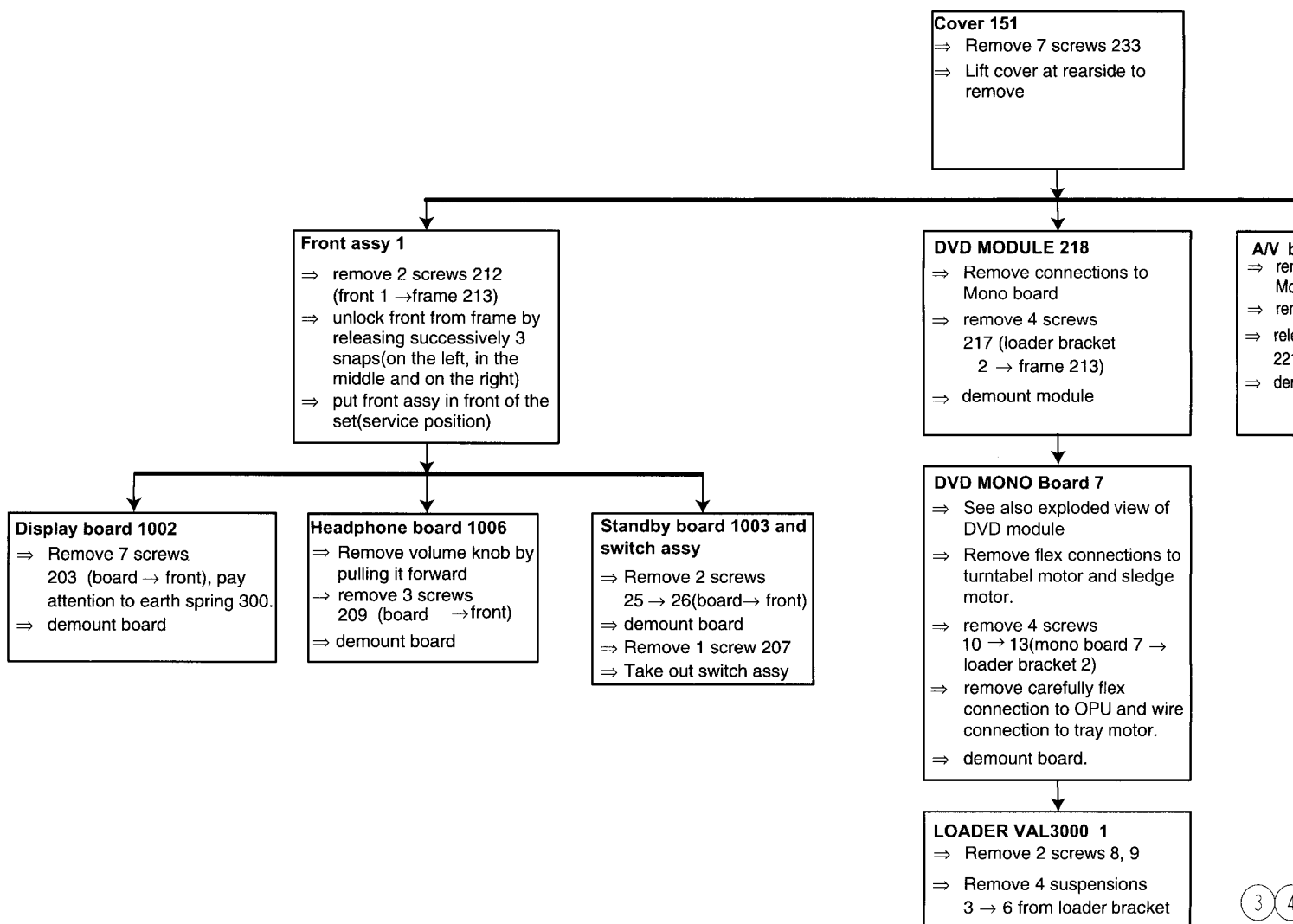

3 4



**cover 151**  
 Remove 7 screws 233  
 Lift cover at rearside to remove

mounting  
 ↑  
 ↓  
 demounting

**DVD MODULE 218**  
 Remove connections to Mono board  
 remove 4 screws 217 (loader bracket 2 → frame 213)  
 demount module

**A/V board 1002**  
 ⇒ remove flex connections to Mono board  
 ⇒ remove 7 screws 227  
 ⇒ release snaps of 2 spacers 221  
 ⇒ demount board

**Power supply unit 1005**  
 ⇒ remove connections  
 ⇒ remove 2 screws 222 (board → frame)  
 ⇒ remove screw 225 (mains inled → backplate)  
 ⇒ release snaps of spacers 226 (board → frame)  
 ⇒ demount board

**DVD MONO Board 7**  
 See also exploded view of DVD module  
 Remove flex connections to turntable motor and sledge motor.  
 remove 4 screws 10 → 13 (mono board 7 → loader bracket 2)  
 remove carefully flex connection to OPU and wire connection to tray motor.  
 demount board.

**LOADER VAL3000 1**  
 Remove 2 screws 8, 9  
 Remove 4 suspensions 3 → 6 from loader bracket

Exploded view DVD MODULE 218

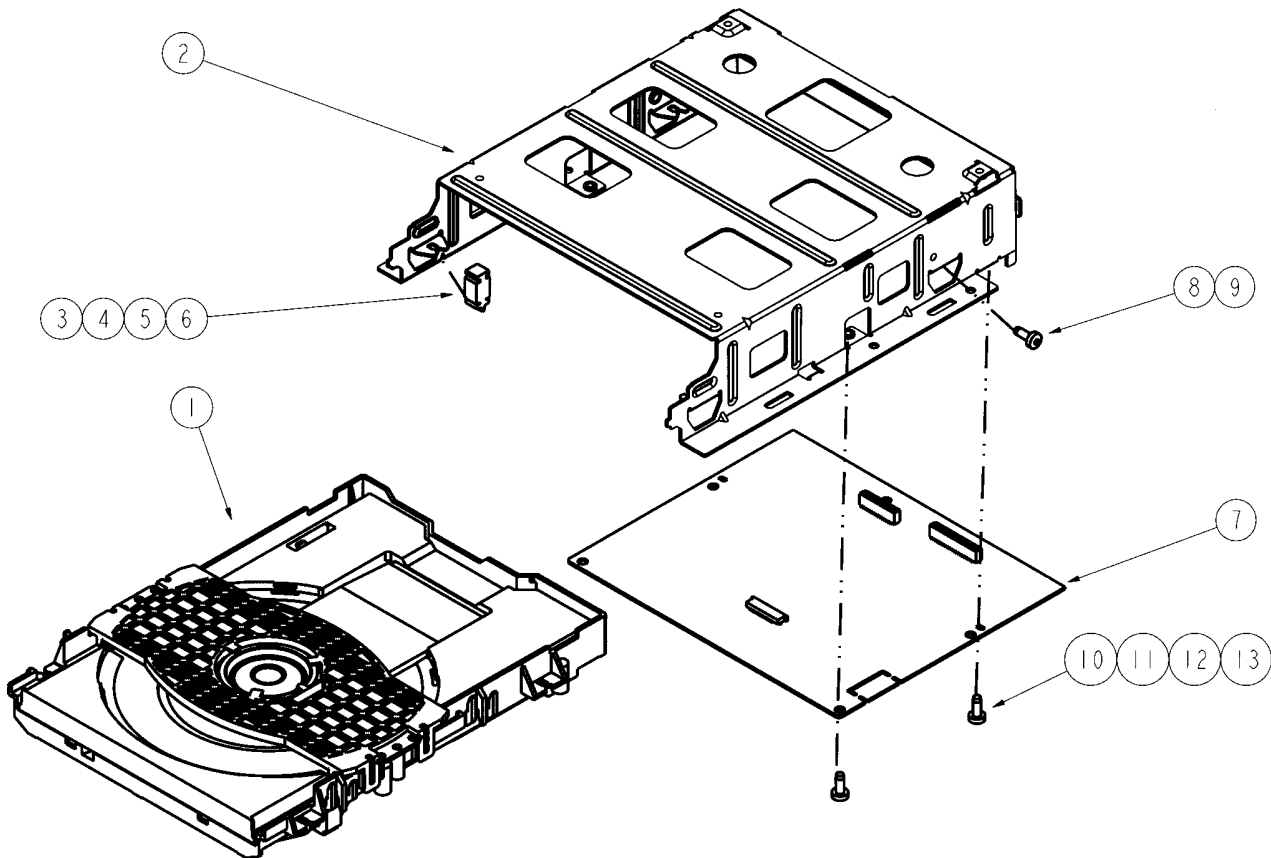



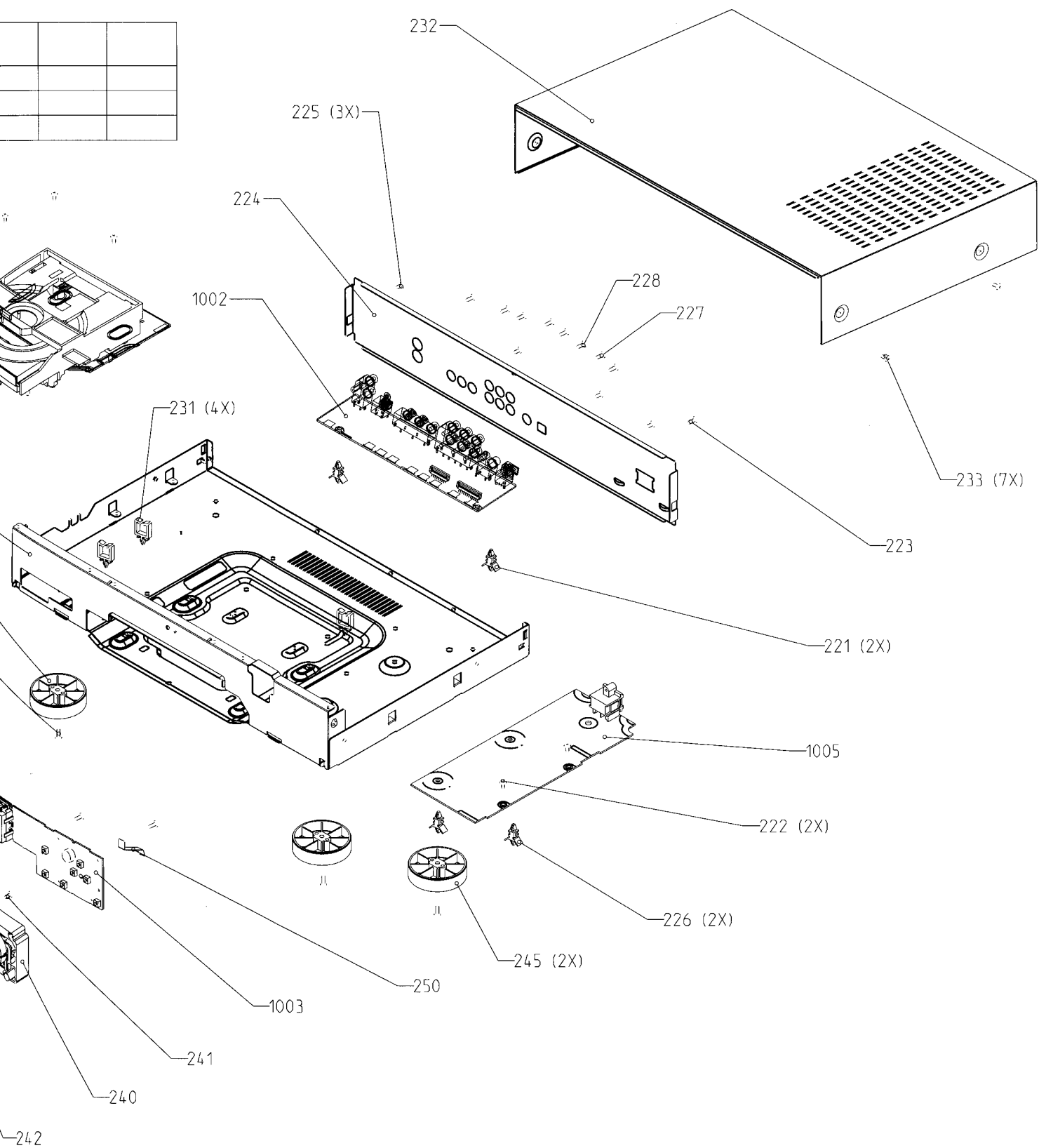

Wiring diagram

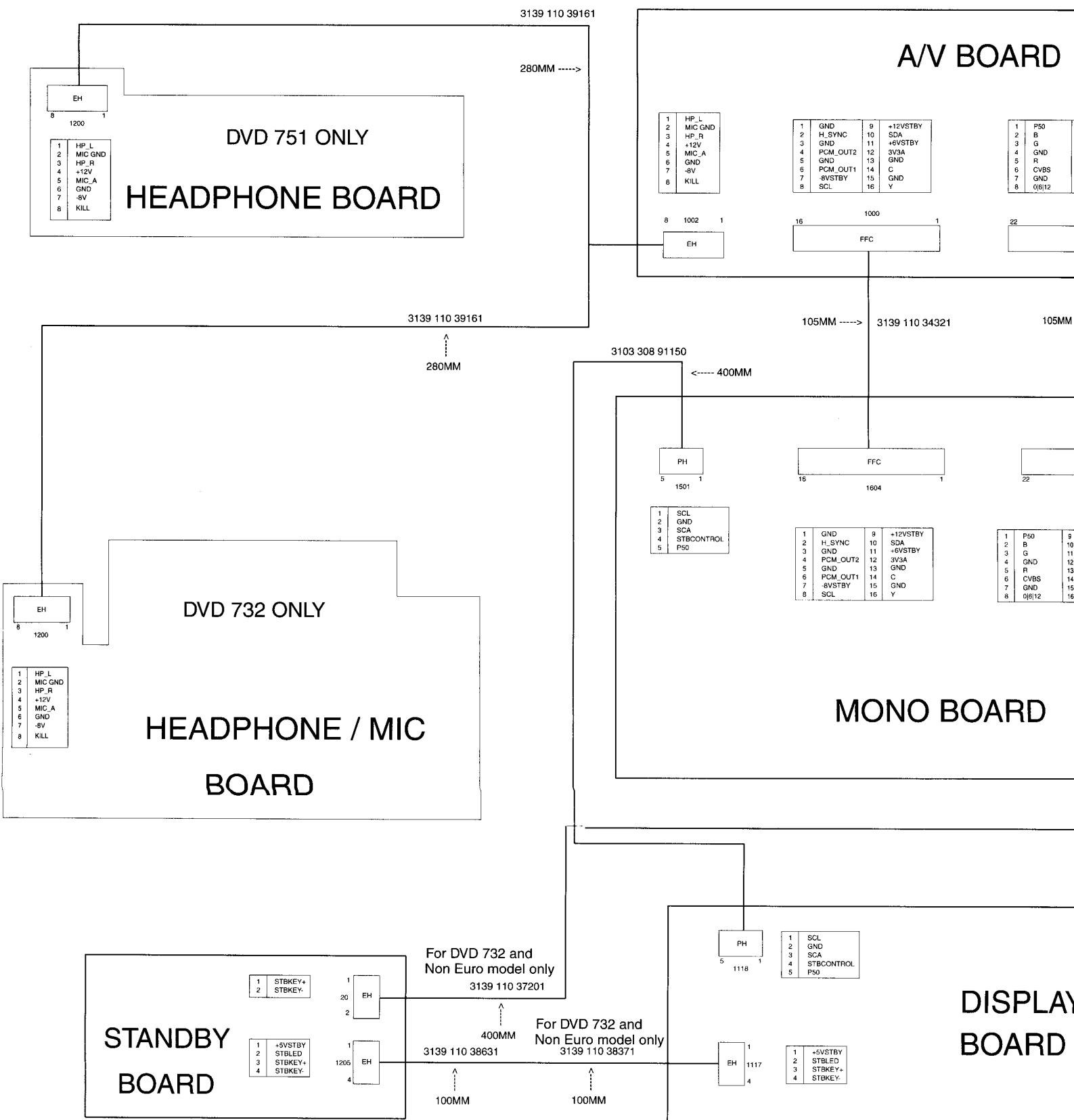

# A/V BOARD

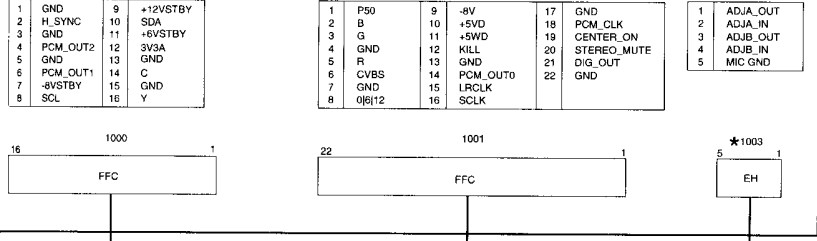

105MM -----> 3139 110 34321      105MM -----> 3139 110 34221      400MM -----> 3139 110 38831

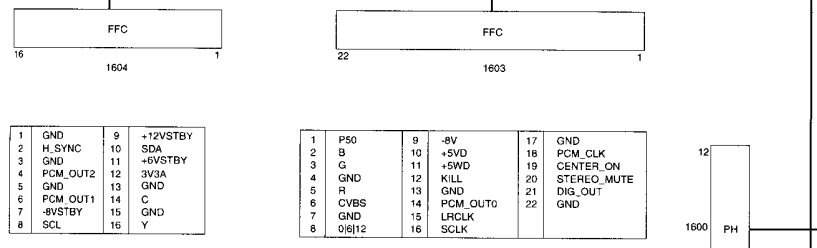

# MONO BOARD

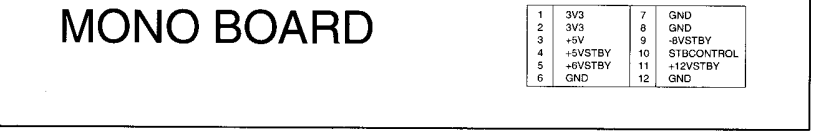

# POWER SUPPLY BOARD

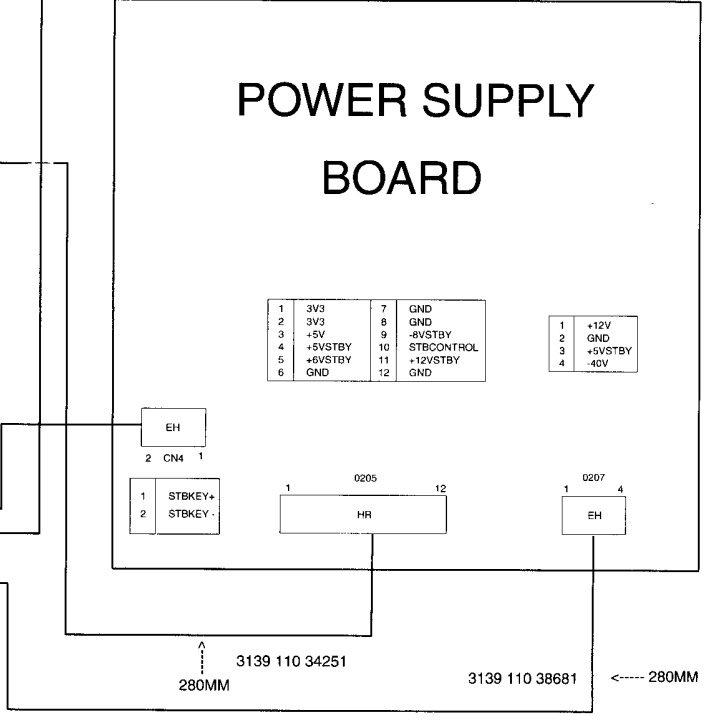

# DISPLAY BOARD

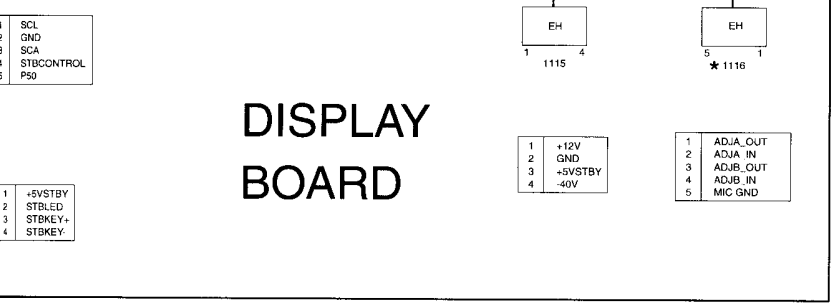

# 6. Electrical diagrams and Print-layouts

## Volume / Standby PWB

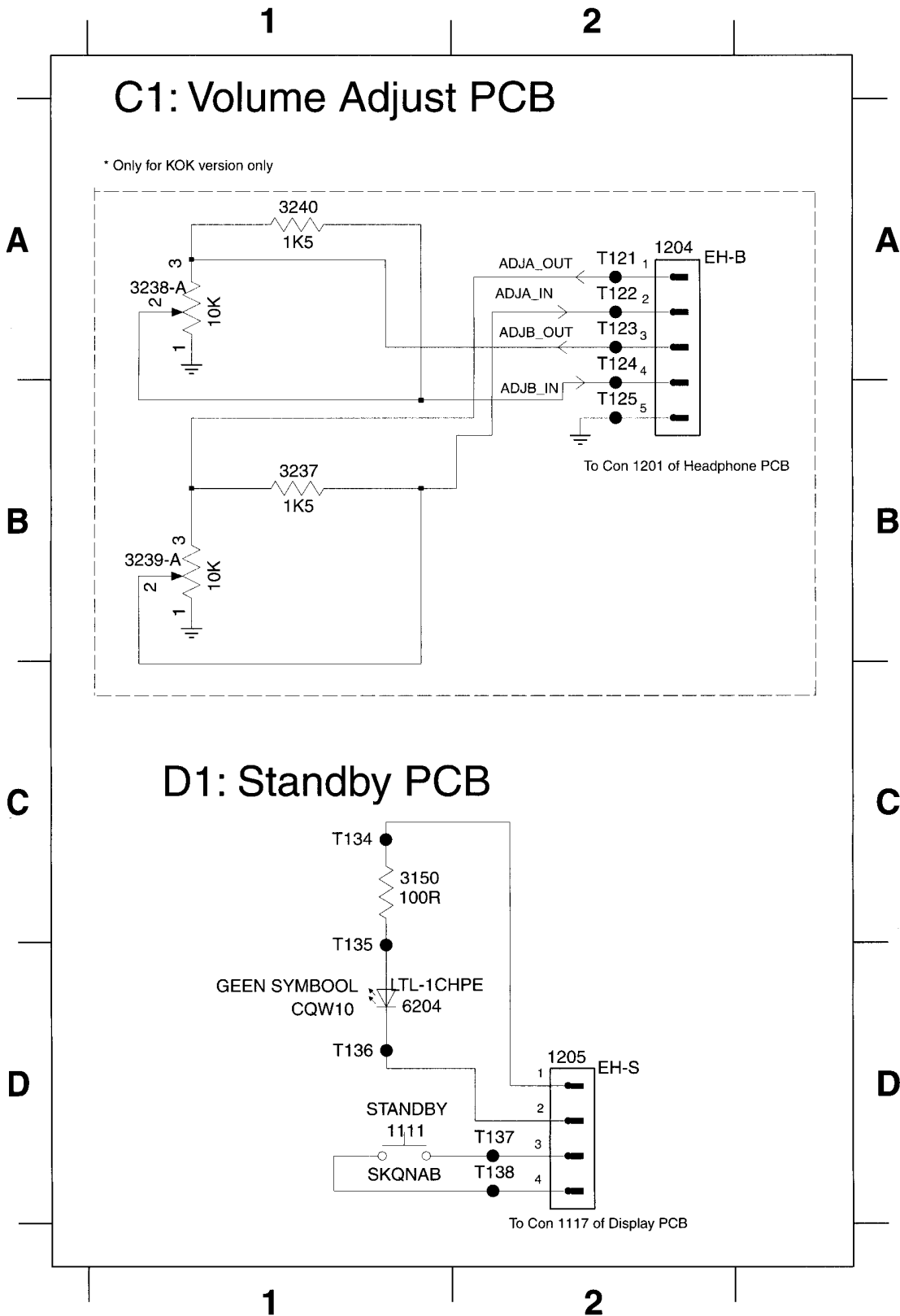

- 1111 D1
- 1204 A2
- 1205 D2
- 3150 C1
- 3237 B1
- 3238-A A1
- 3239-A B1
- 3240 A1
- 6204 D1
- T121 A2
- T122 A2
- T123 A2
- T124 A2
- T125 B2
- T134 C1
- T135 D1
- T136 D1
- T137 D2
- T138 D2

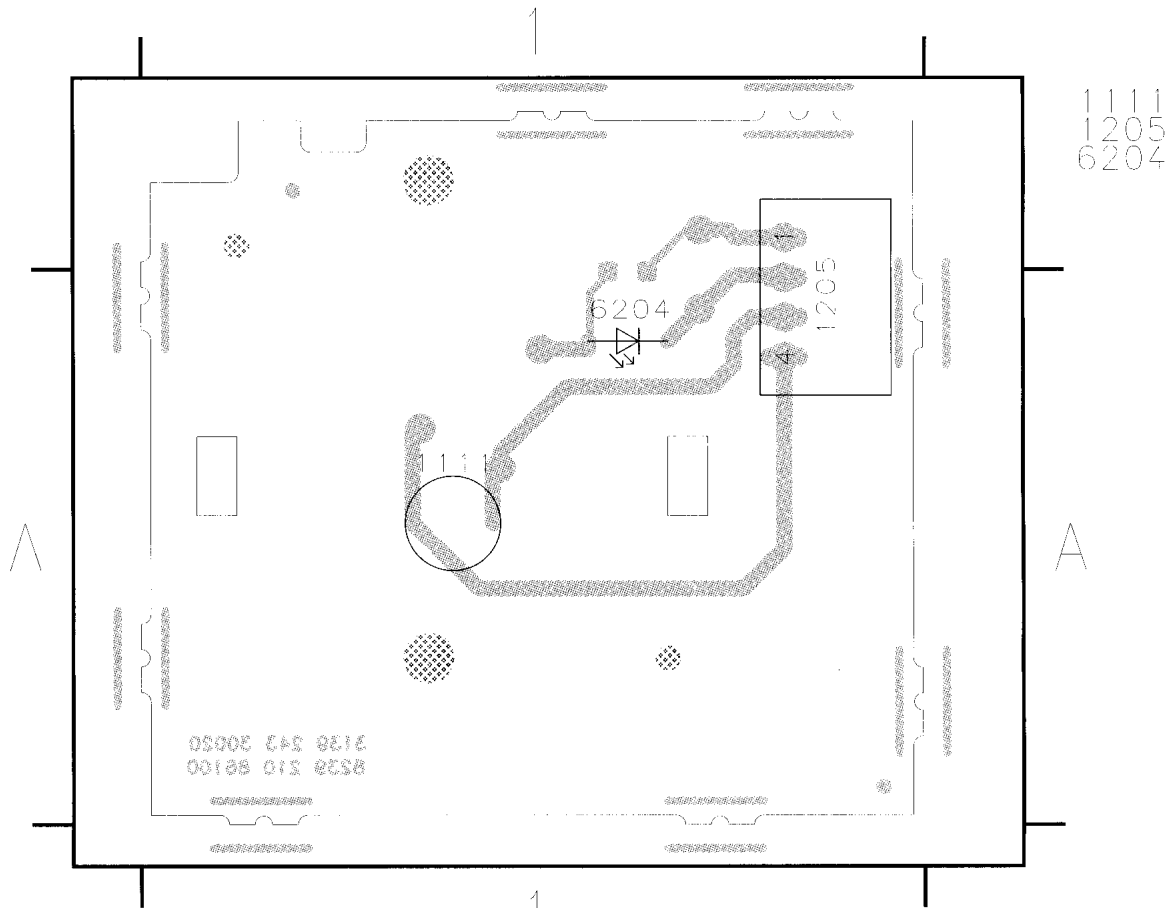

CL 96532070\_014.eps  
160799

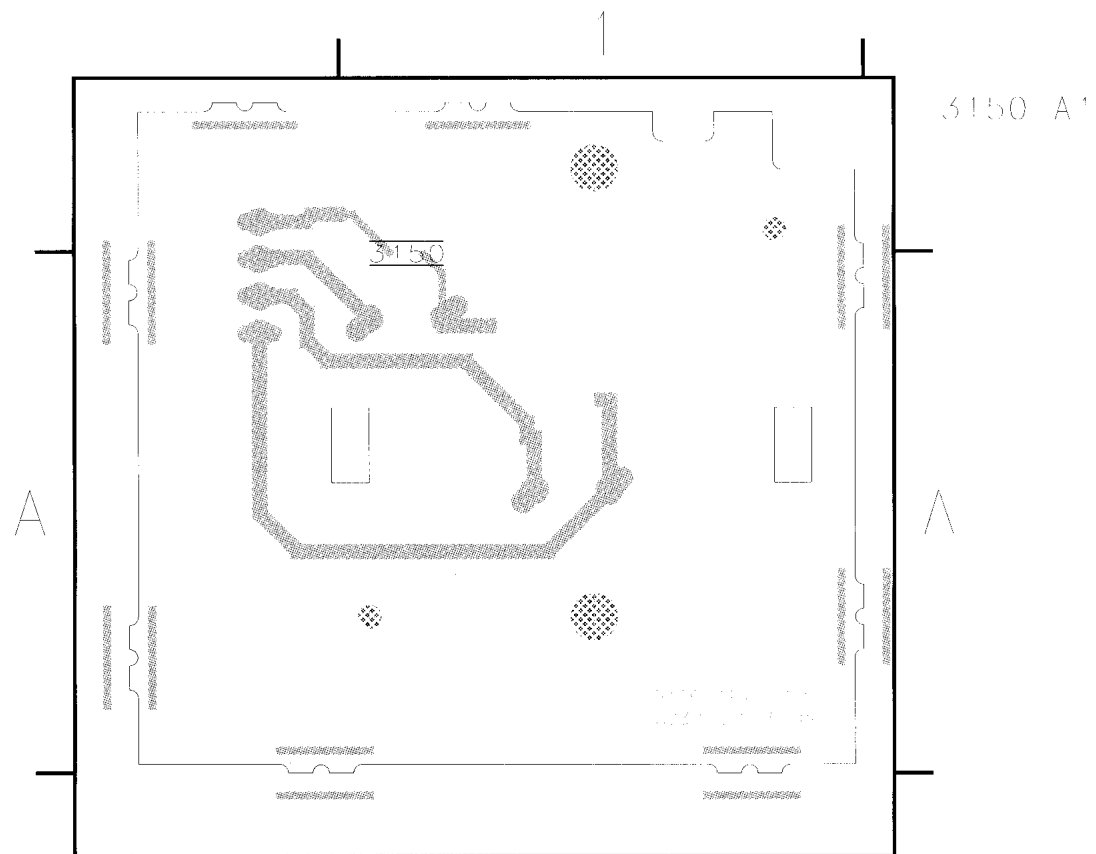



# Display

## A1 : FRONT DISPLAY PCB

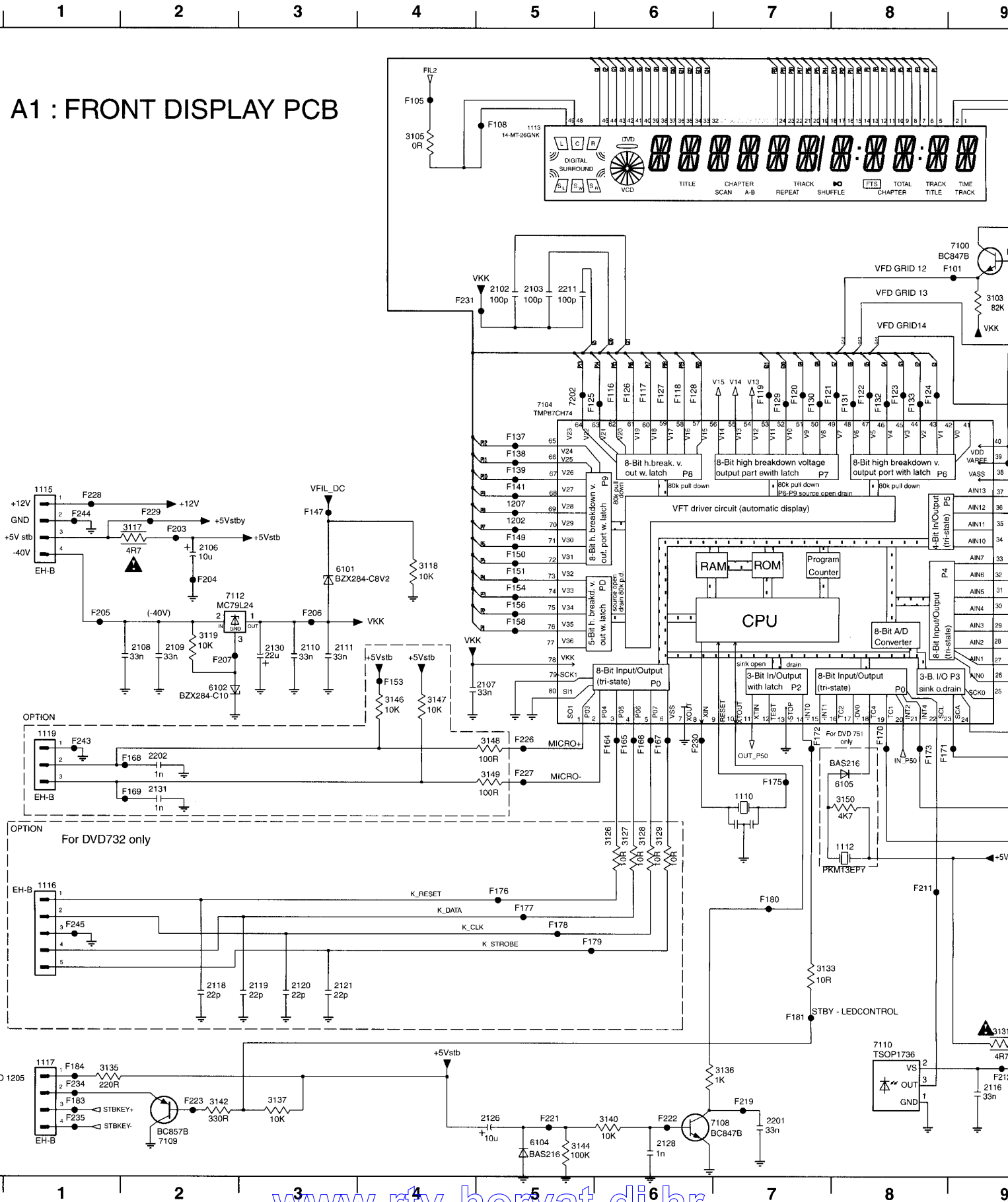

7 8 9 10 11 12 13 14

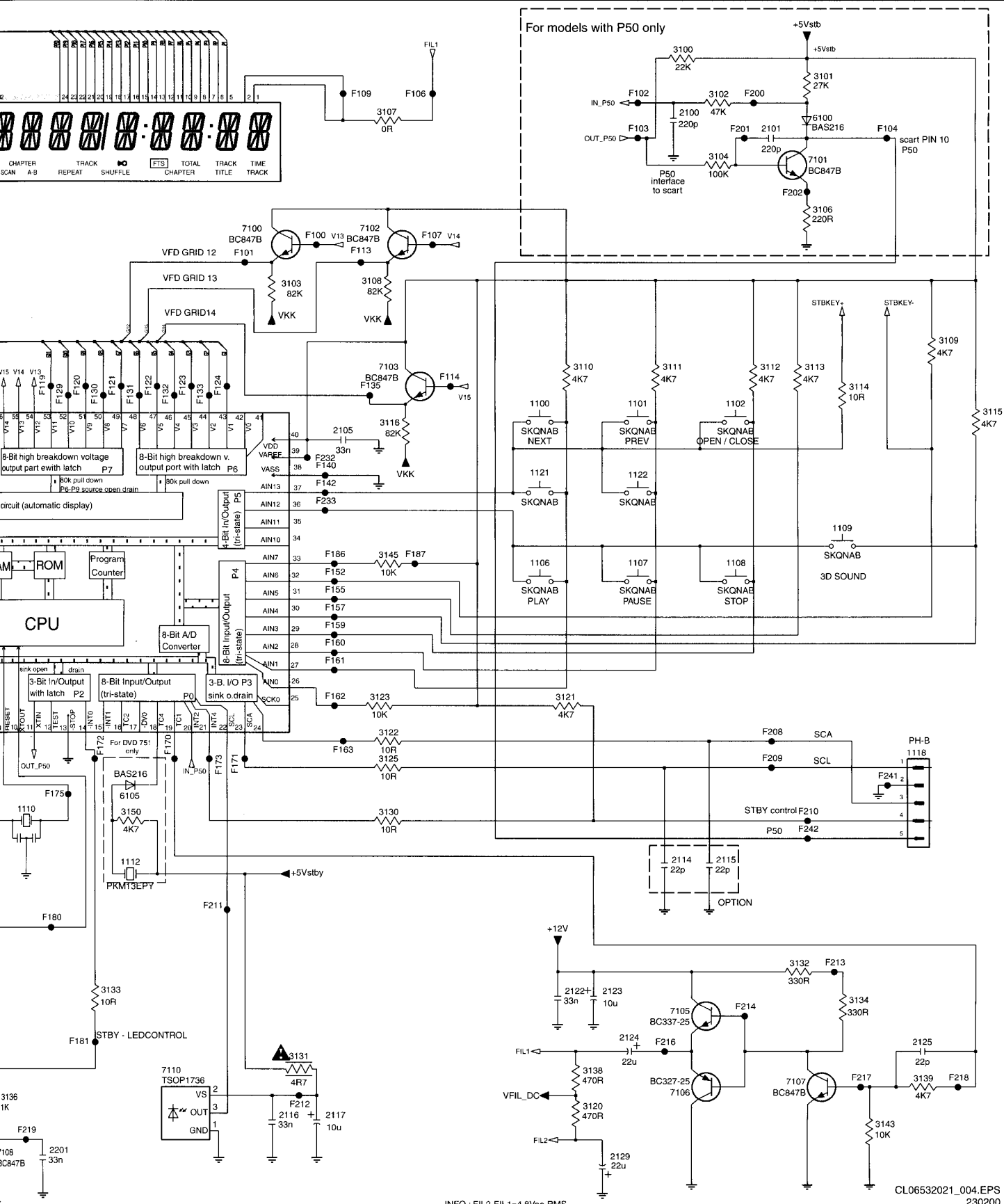

INFO : FIL2-FIL1=4.8Vac-RMS CL06532021\_004.EPS 230200

7 8 9 10 11 12 13 14

Display PWB

1100 A9101 A9102 A8106 A9107 A8108 A9109 A8110 A4112 A9113 A4115 A7116 A8117 A1118 A1119 A6121 A9122 A9106 A2117 A2123 A2

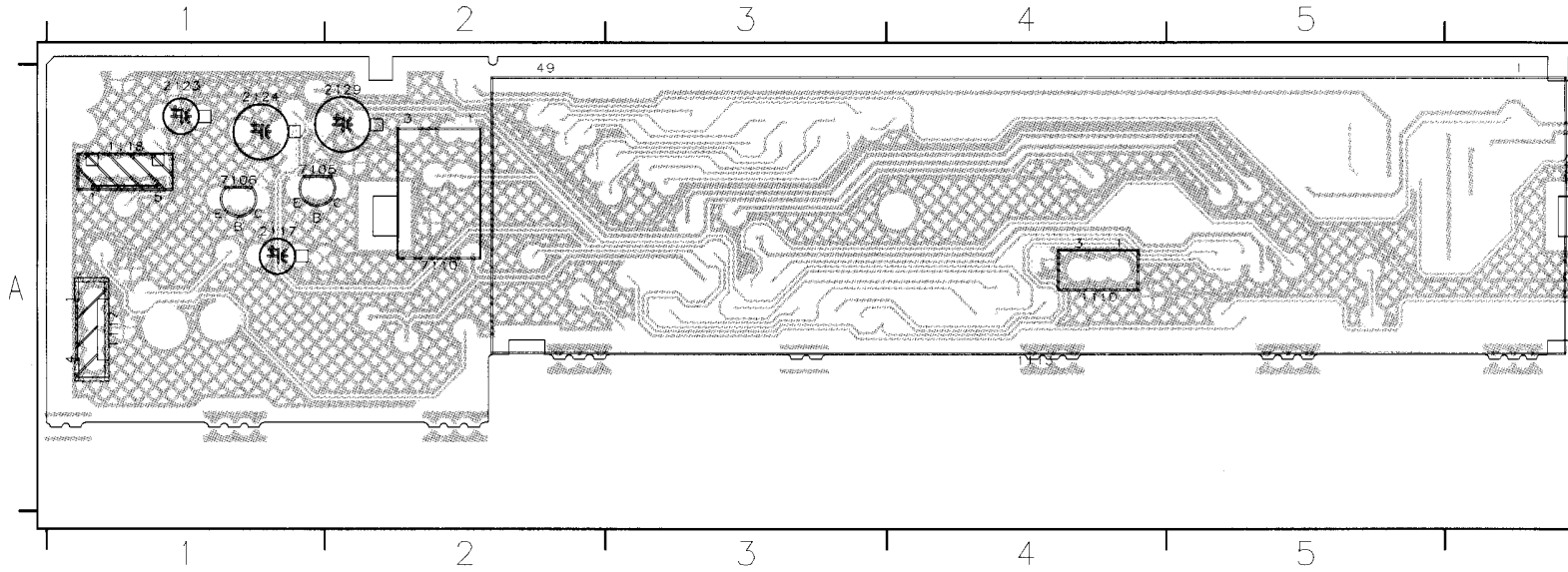

2100 A2103 A8108 A3111 A4116 A9120 A3125 A9201 A13100 A2103 A8106 A2109 A8112 A13115 A3118 A2121 A9125 A9128 A3131 A8134 A9101 A2105 A8109 A3114 A9118 A3121 A3128 A2202 A4101 A2104 A3107 A4110 A8113 A8116 A8119 A3122 A9126 A3129 A3132 A9135 A9102 A8107 A8110 A4115 A9119 A3122 A8131 A4211 A8102 A2105 A8108 A8111 A13114 A8117 A3120 A8123 A3127 A3130 A9133 A9136 A2

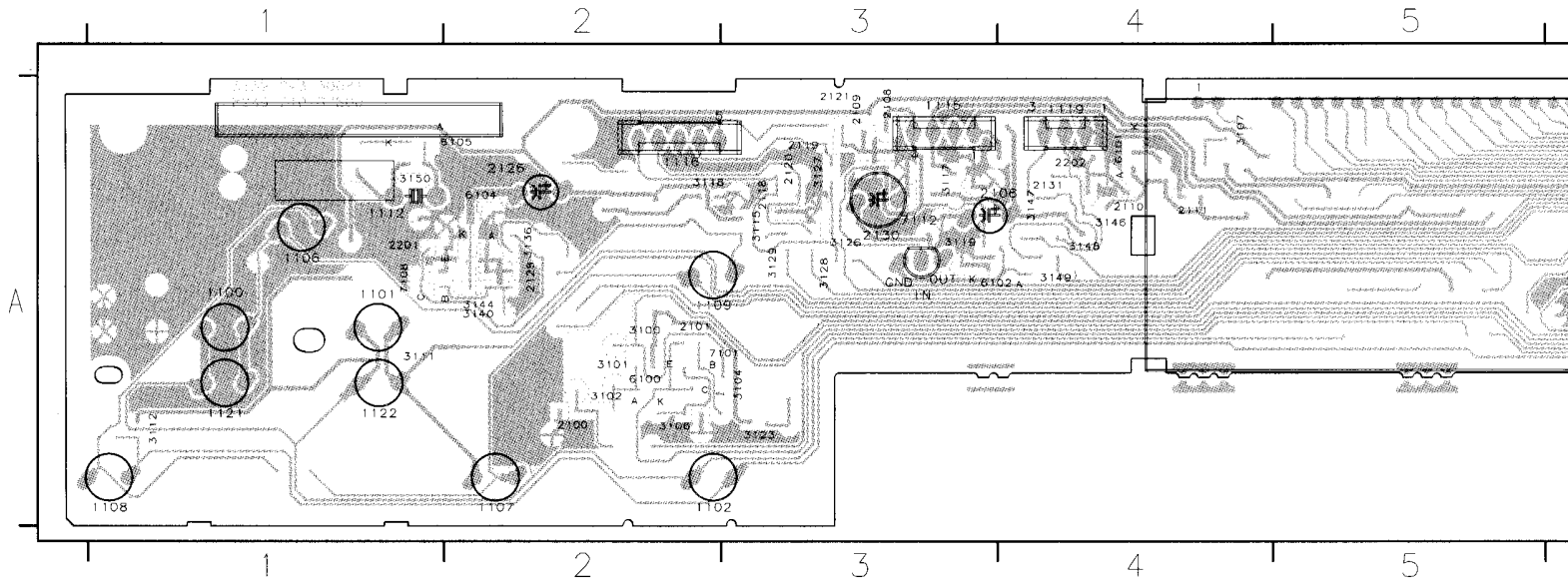



### TROUBLESHOOTING DISPLAY BOARD

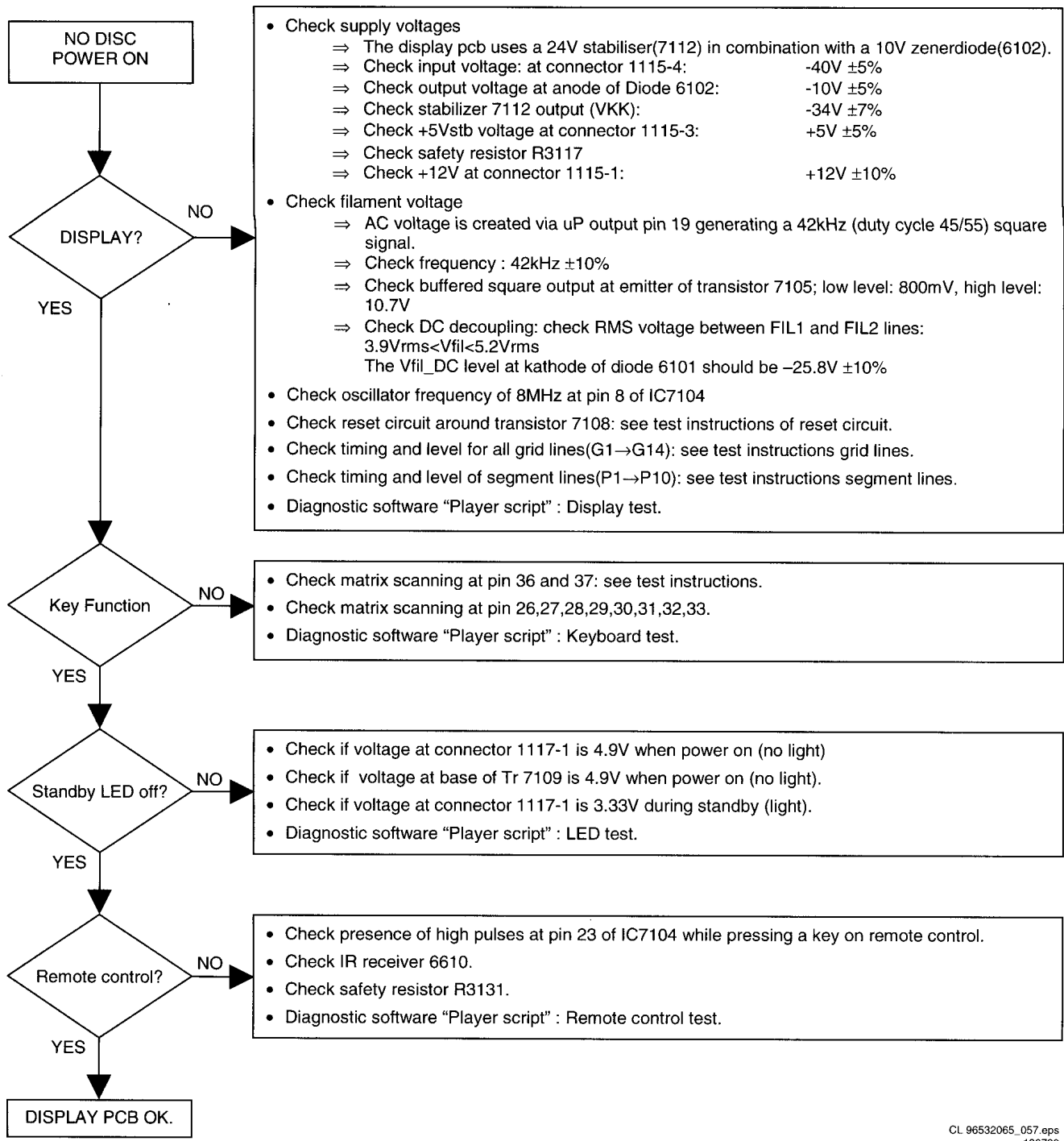

CL 96532065\_057.eps  
130799

Figure 6-1

## TROUBLESHOOTING A/V BOARD

Testing of A/V board can be done using diagnostic software "Player script". Mono board is used to generate a sinus with the soundtest SND-2 or a VIDEO signal with the picture test PIC-1. See description in chapter "Diagnostic Software : Script Interfaces"

### AUDIO PART

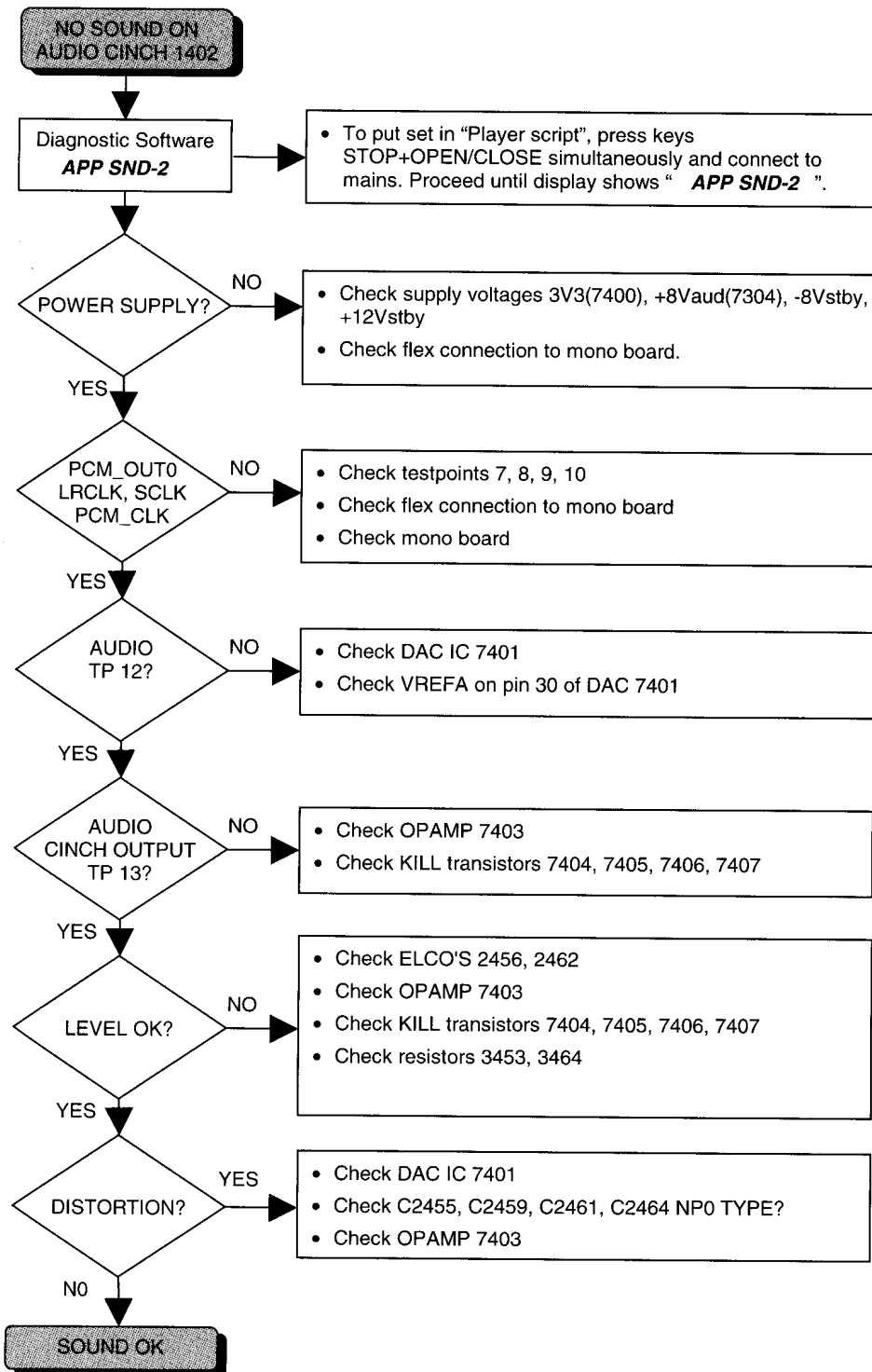

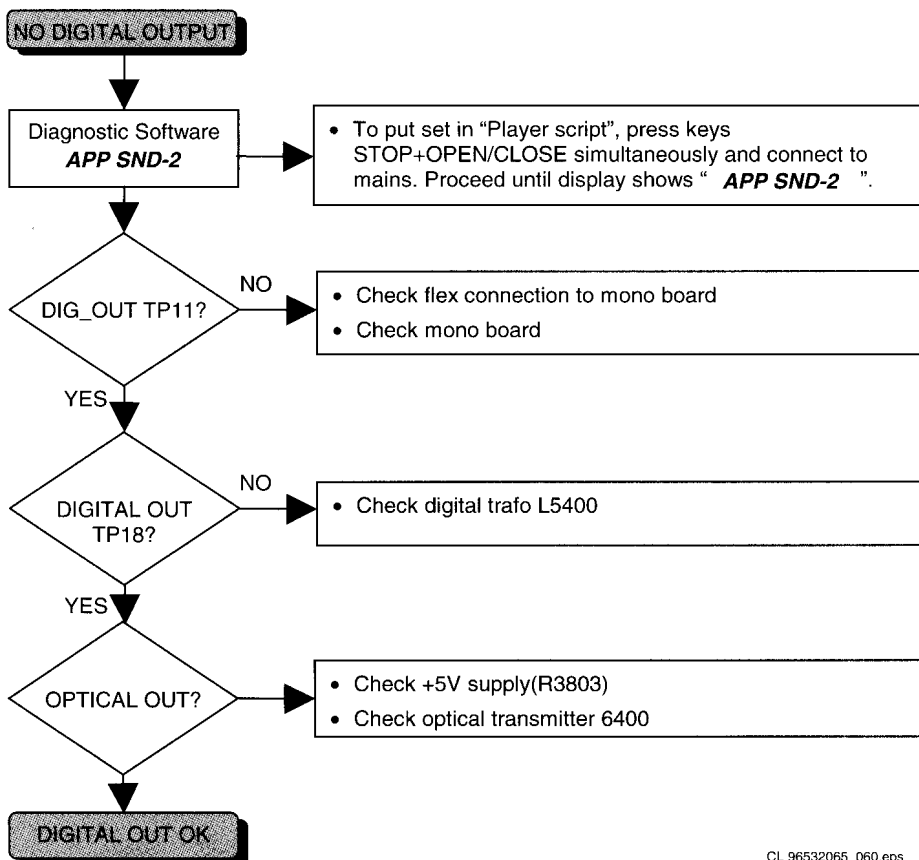
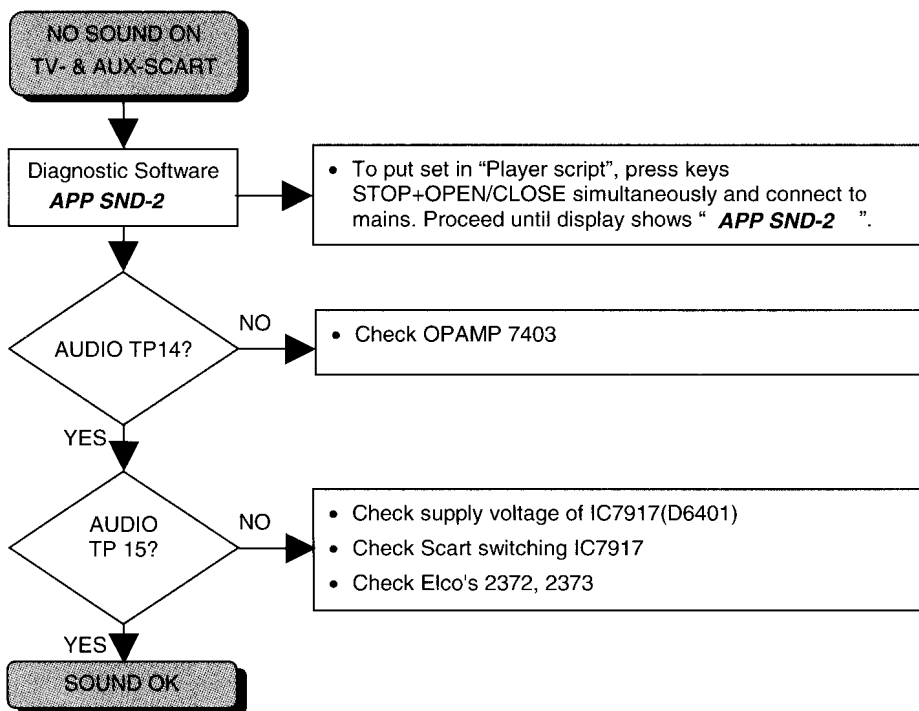

CL 96532065\_060.eps  
130799

## VIDEO PART

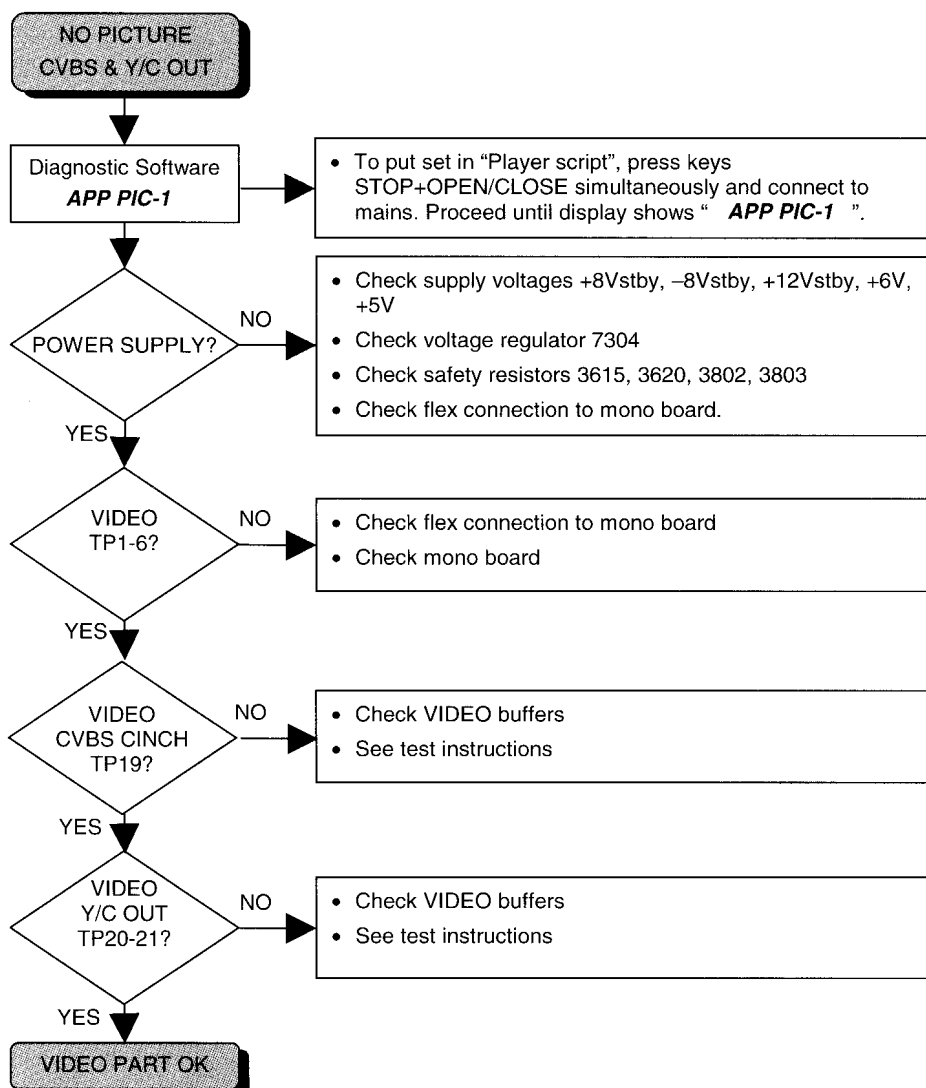

CL 96532065\_061.eps  
130799



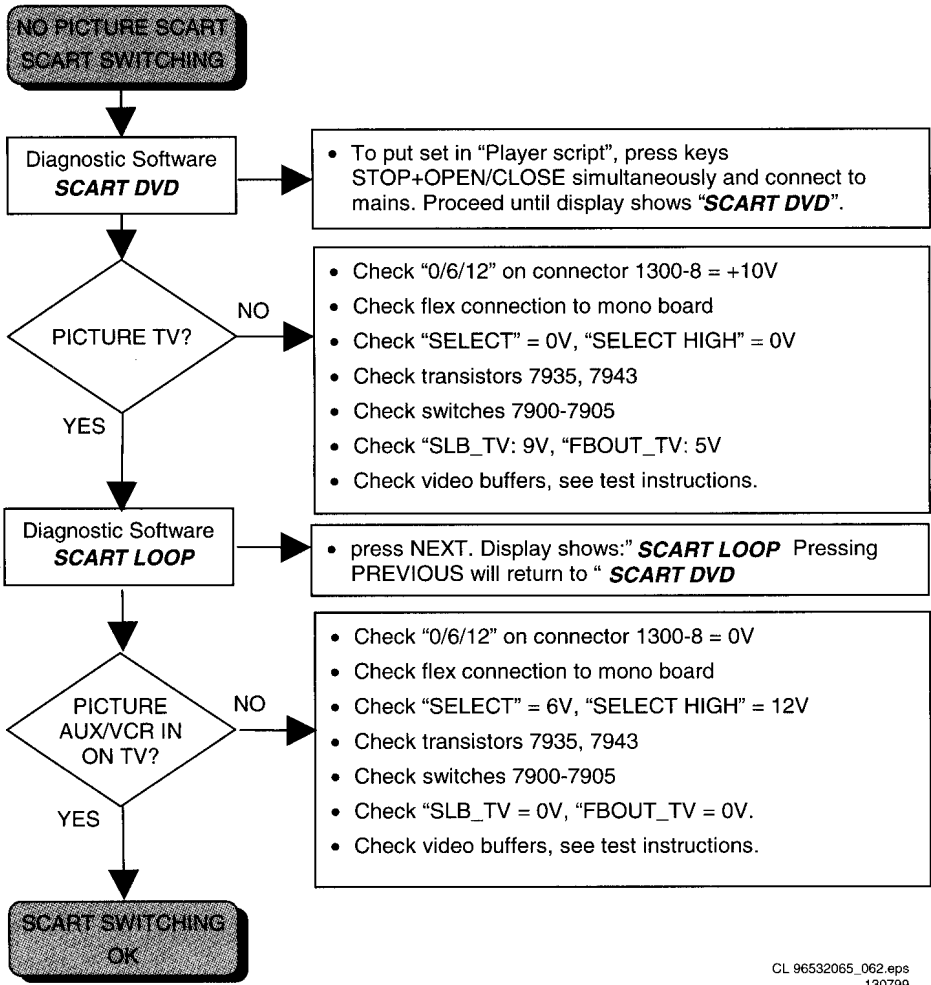

CL 96532065\_062.eps  
130799

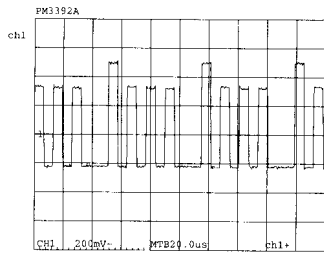

TP 1 : video B

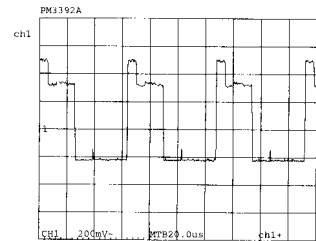

TP 2 : video G

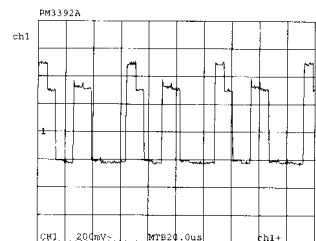

TP 3 : video R

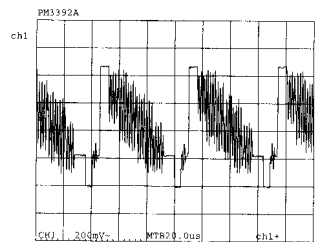

TP 4 : CVBS

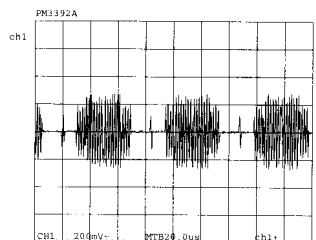

TP 5 : C\_ENC

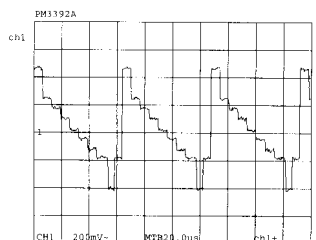

TP 6 : Y\_ENC

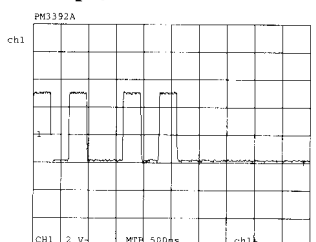

TP7 : PCM\_OUT0

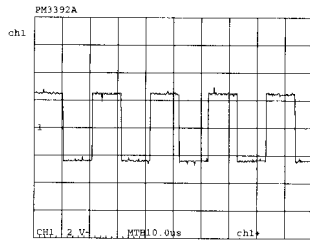

TP8 : LRCK

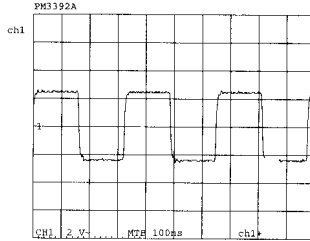

TP9 : SCLK

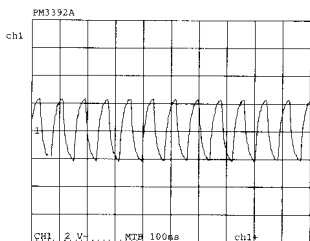

TP10 : PCM\_CLK

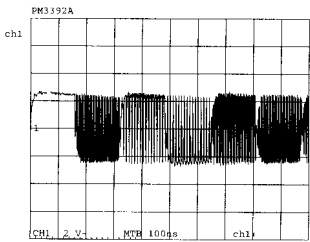

TP 11 : DIG\_OUT

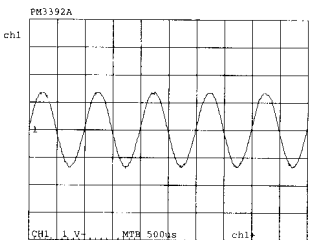

TP 12 : ANALOG OUTPUT DAC

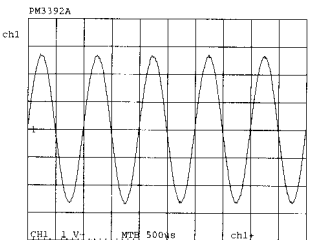

TP 13 : ANALOG OUTPUT AUDIO CINCH

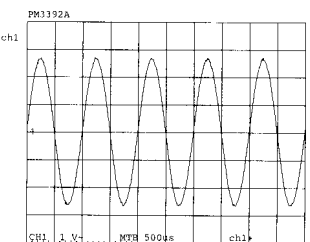

TP 14 : ANALOG OUTPUT AUDIO HP\_R & HP\_L

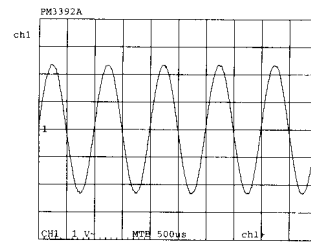

TP 15 : AUDIO SCART SWITCH OUTPUT

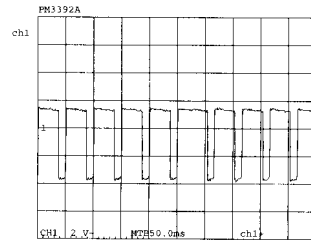

TP16 : SDA

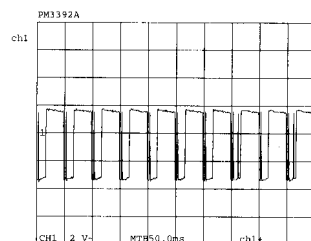

TP17 : SCL

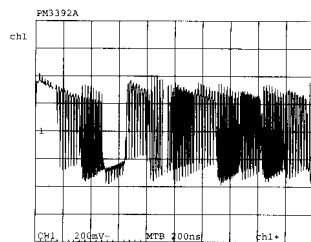

TP18 : DIGITAL OUT

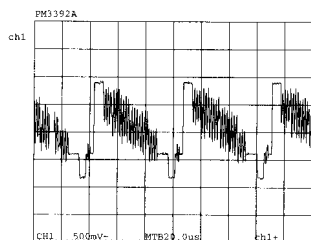

TP 19 : CVBS\_OUT

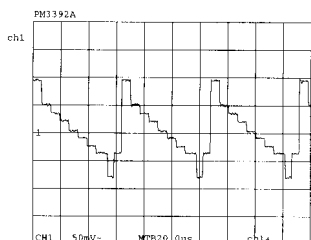

TP 20 : Y\_OUT

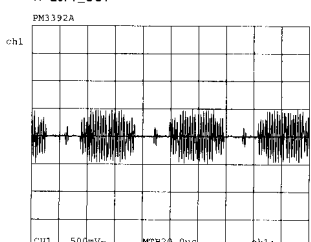

TP 21 : C\_OUT

AV board

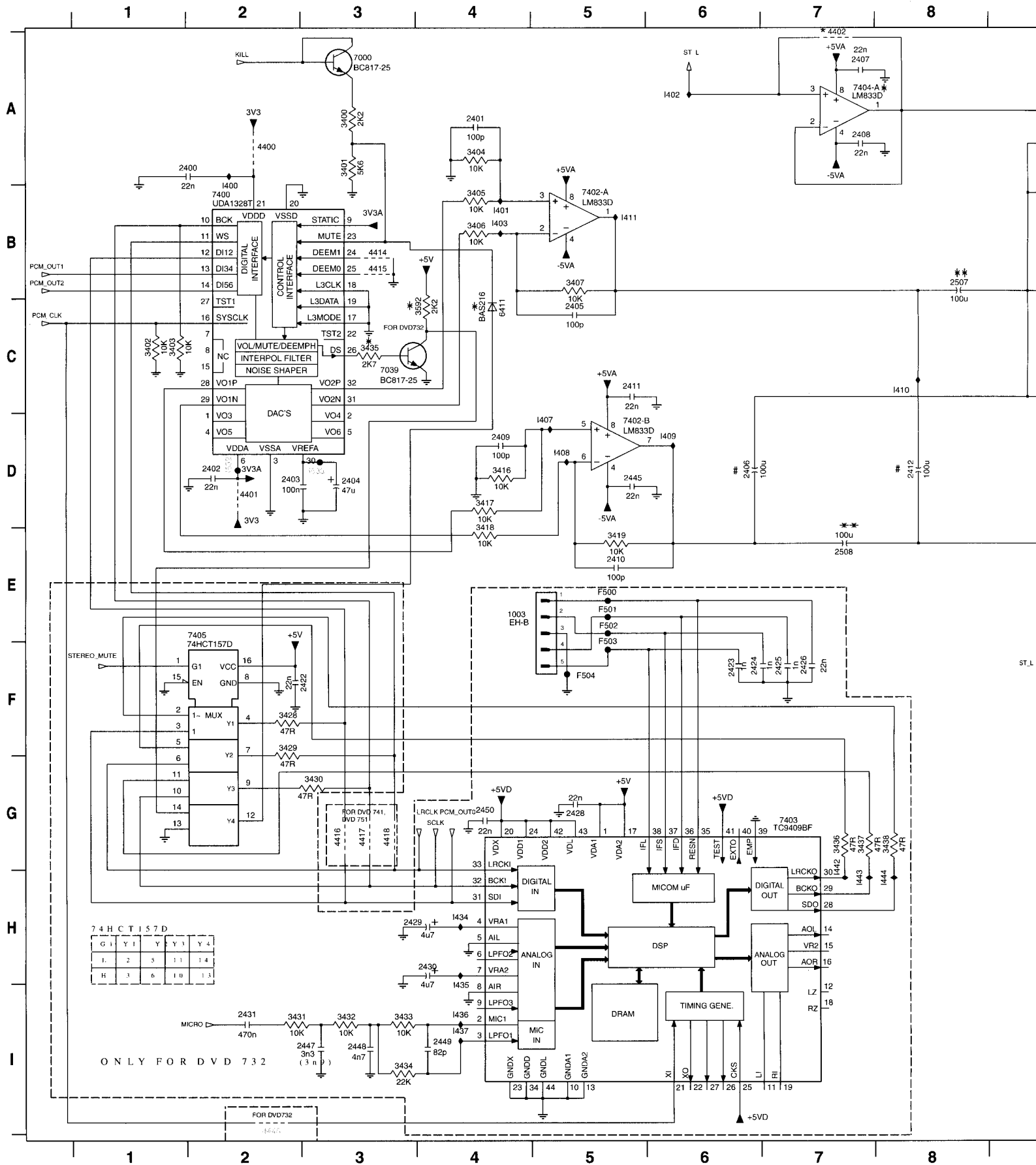

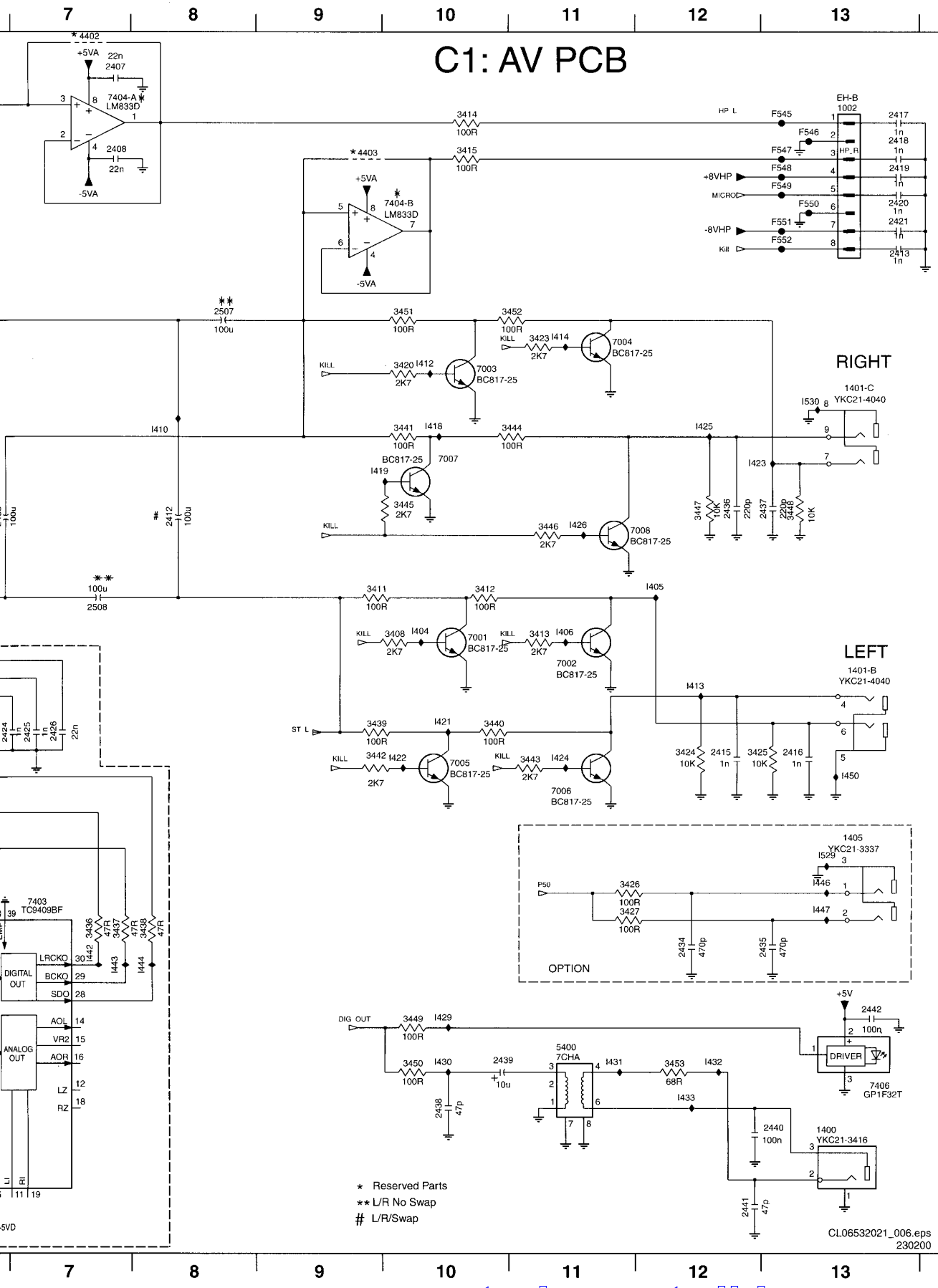

1002 A13	7001 B7
1003 E4	7002 B8
1400 I13	7003 F10
1401-B B13	7004 F11
1401-C F13	7005 D8
1405 D13	7006 E9
2400 A2	7007 C10
2401 A4	7008 H12
2402 D2	7039 C3
2403 D2	7400 B2
2404 D3	7402-A B5
2405 C5	7402-B D5
2406 B6	7403 G7
2407 A7	7404-A A7
2408 A7	7404-B C9
2409 D4	7405 E2
2410 E5	7406 H13
2411 C5	F500 E5
2412 D6	F501 E5
2413 B13	F502 E5
2415 C12	F503 F5
2416 C13	F504 F5
2417 A13	F545 A13
2418 A13	F546 A13
2419 A13	F547 A13
2420 B13	F548 A13
2421 B13	F549 A13
2422 F2	F550 B13
2423 F6	F551 B13
2424 F6	F552 B13
2425 F7	I400 B2
2426 F7	I401 B4
2428 G5	I402 A6
2429 H3	I403 B4
2430 H4	I404 B6
2431 I2	I405 B12
2434 D12	I406 B8
2435 D13	I407 D5
2436 G12	I408 D5
2437 G13	I409 D6
2438 I10	I410 C6
2439 H10	I411 B5
2440 I13	I412 F10
2441 I12	I413 B12
2442 H13	I414 E11
2445 D5	I418 F10
2447 I3	I419 G10
2448 I3	I421 D8
2449 I4	I422 D8
2450 G4	I423 F13
2507 C5	I424 D9
2508 C5	I425 F12
3400 A3	I426 G11
3401 A3	I429 H10
3402 C1	I430 H10
3403 C1	I431 H11
3404 A4	I432 H12
3405 B4	I433 I12
3406 B4	I434 H4
3407 B5	I435 I4
3408 B6	I436 I4
3411 B6	I437 I4
3412 B7	I442 G7
3413 B7	I443 H7
3414 A10	I444 H8
3415 A10	I446 D13
3416 D4	I447 D13
3417 D4	I450 C13
3418 E4	I529 D13
3419 E5	I530 F13
3420 F10	I532 D2
3423 F11	I533 D3
3424 C12	
3425 C12	
3426 D12	
3428 F2	
3429 F2	
3430 G3	
3431 I2	
3432 I3	
3433 I3	
3434 I3	
3435 C3	
3436 G7	
3437 G7	
3438 G8	
3439 D7	
3440 D9	
3441 F10	
3442 D7	
3443 D9	
3444 F11	
3445 G10	
3446 G11	
3447 G12	
3448 G13	
3449 H10	
3450 H10	
3451 E10	
3452 E11	
3453 H12	
3592 C4	
4400 A2	
4401 D2	
4402 A7	
4403 B8	
4414 B3	
4415 B3	
4416 G3	
4417 G3	
4418 G3	
4440 I2	
5400 H11	
6411 C4	
7000 A3	

\* Reserved Parts  
 \*\* L/R No Swap  
 # L/R/Swap

CL06532021\_006.eps  
 230200



# C2: AV PCB

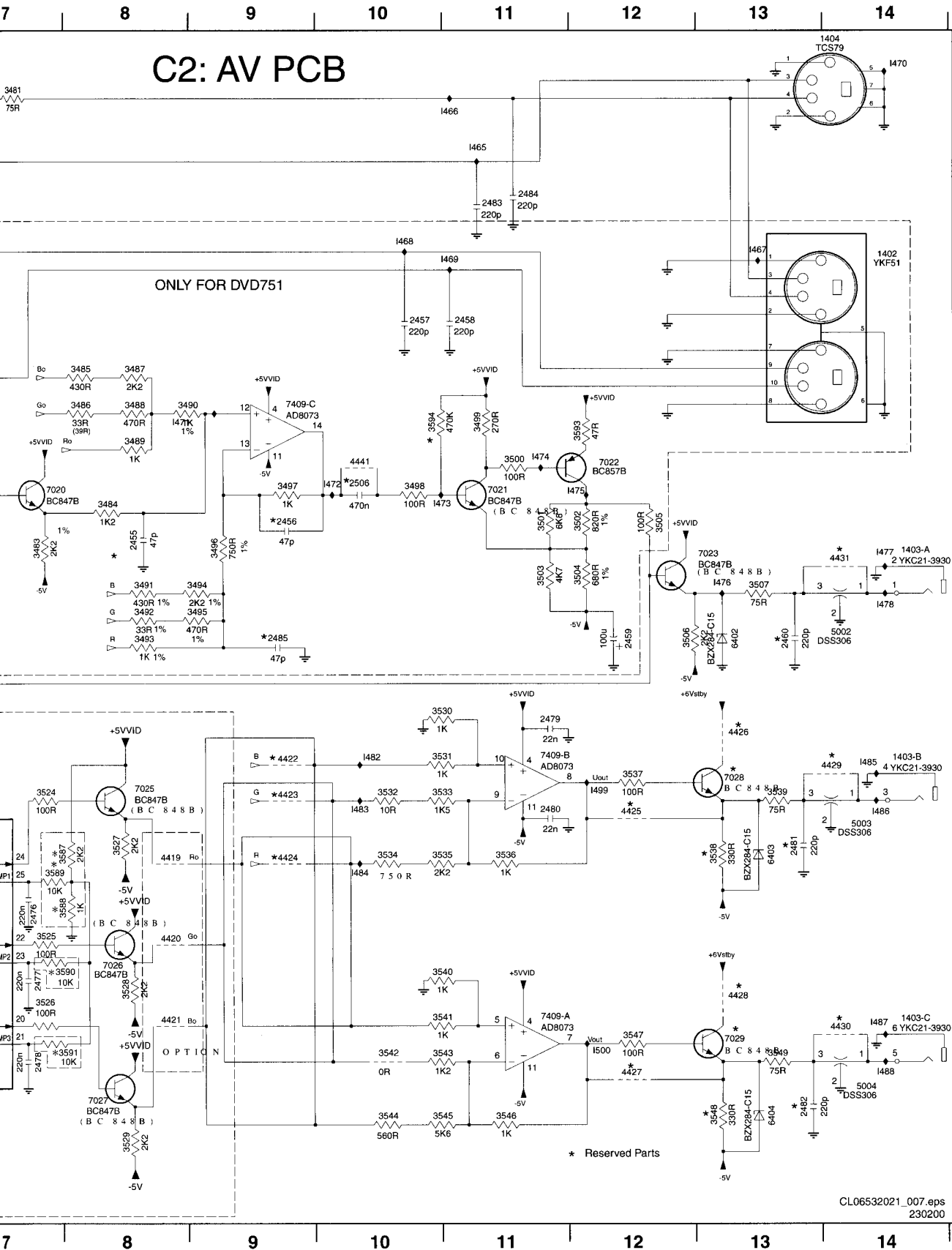

1402 B14	3526 H7	I481 G3
1403-A D14	3527 G8	I482 F10
1403-B F14	3528 H8	I483 F10
1403-C H14	3529 I8	I484 G10
1404 A14	3530 F10	I485 F14
2451 B4	3531 F10	I486 F14
2452 C3	3532 F10	I487 H14
2453 D3	3533 F10	I488 I14
2454 C5	3534 G10	I489 C1
2455 D8	3535 G10	I490 C2
2456 D9	3536 G11	I491 D2
2457 C10	3537 F12	I492 D2
2458 C11	3538 G13	I493 C3
2459 E12	3539 F13	I494 C3
2460 E13	3540 H10	I495 C4
2461 G2	3541 H10	I496 A3
2462 G2	3542 H10	I497 D5
2463 G2	3543 H10	I498 E5
2464 G2	3544 I10	I499 F12
2465 G3	3545 I10	I500 H12
2466 H2	3546 I11	I501 I5
2467 H3	3547 H12	I502 I5
2468 H3	3548 I13	I507 B2
2469 H2	3549 H13	4441 D10
2470 F4	3550 E3	
2471 F4	3551 D2	
2472 F6	3552 C3	
2473 I4	3586 D4	
2474 I5	3587 G8	
2475 I6	3588 G8	
2476 G7	3589 G7	
2477 H7	3590 H8	
2478 H7	3591 H8	
2479 F11	3593 C12	
2480 F11	3594 C10	
2481 G13	4419 G8	
2482 I13	4420 G8	
2483 B11	4421 H8	
2484 B11	4422 F9	
2485 E9	4423 F9	
2506 D10	4424 G9	
3454 A1	4425 F12	
3455 A1	4426 F13	
3456 A1	4427 I12	
3457 A2	4428 H13	
3458 A3	4429 F14	
3459 A4	4430 H14	
3460 A4	4431 D14	
3461 B2	5002 E14	
3462 B2	5003 G14	
3463 B3	5004 I14	
3464 B3	6400 D4	
3465 C3	6401 E5	
3466 C3	6402 E13	
3467 B4	6403 G13	
3468 C4	6404 I13	
3469 C5	6412 C6	
3470 C2	6413 C6	
3471 C2	7009 B2	
3472 D2	7010 A3	
3473 D2	7011 A2	
3474 D2	7012 B2	
3475 D4	7013 B3	
3476 E5	7014 B4	
3477 D5	7015 C1	
3478 E6	7016 C2	
3479 C6	7017 C4	
3480 C5	7018 C5	
3481 A7	7019 D5	
3482 D7	7020 D7	
3483 D7	7021 D11	
3484 D8	7022 D12	
3485 C8	7023 D13	
3486 C8	7024 I2	
3487 C8	7025 F8	
3488 C8	7026 H8	
3489 D8	7027 I8	
3490 C8	7028 F13	
3491 E8	7029 H13	
3492 E8	7408 F3	
3493 E8	7409-A H11	
3494 E9	7409-B F11	
3495 E9	7409-C C9	
3496 D9	I451 A2	
3497 D9	I452 B1	
3498 D10	I453 A2	
3499 C11	I454 B2	
3500 D11	I455 C2	
3501 D11	I456 B3	
3502 D12	I457 B3	
3503 E11	I458 D4	
3504 E12	I459 B3	
3505 D12	I460 A5	
3506 E12	I461 B4	
3507 E13	I462 B4	
3508 H1	I463 C5	
3509 I1	I464 C5	
3510 I1	I465 A11	
3511 H2	I466 A11	
3512 G2	I467 B13	
3513 G2	I468 B10	
3514 H2	I469 B11	
3515 H2	I470 A14	
3516 H2	I471 C8	
3517 H2	I472 D10	
3518 F3	I473 D10	
3519 F3	I474 D11	
3520 F5	I475 D12	
3521 I5	I476 E13	
3522 I5	I477 D14	
3523 I6	I478 E14	
3524 F7	I479 G3	
3525 G7	I480 G3	

CL.06532021\_007.eps  
230200

A/V board

C3 : AV PC

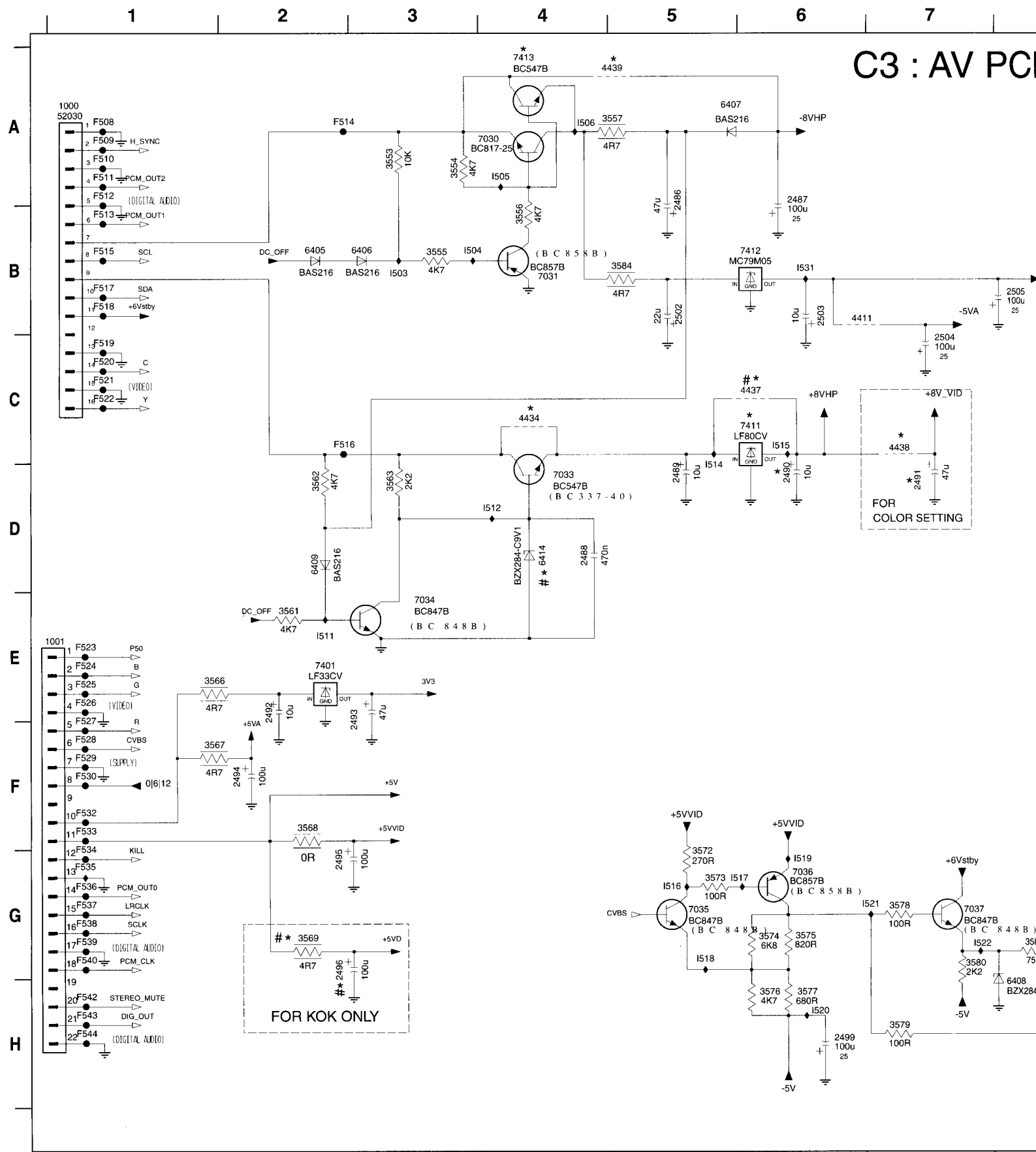

FOR COLOR SETTING

FOR KOK ONLY





AV Pwb (DVD 751)

1000 A4	1003 A1	1402 A7	1405 A2	2412 A4	2439 A2	2459 A6	2489 A6	2492 A2	2495 A5	2502 A5	2505 A5	5000 A4	5001 A4
1001 A3	1400 A3	1403 A5	2404 A2	2429 A1	2452 A8	2486 A6	2490 A6	2493 A3	2496 A2	2503 A6	2507 A3	5001 A5	5004 A5
1002 A5	1401 A4	1404 A6	2406 A3	2430 A1	2453 A8	2487 A6	2491 A7	2494 A4	2499 A5	2504 A5	2508 A4	5002 A6	5400 A6

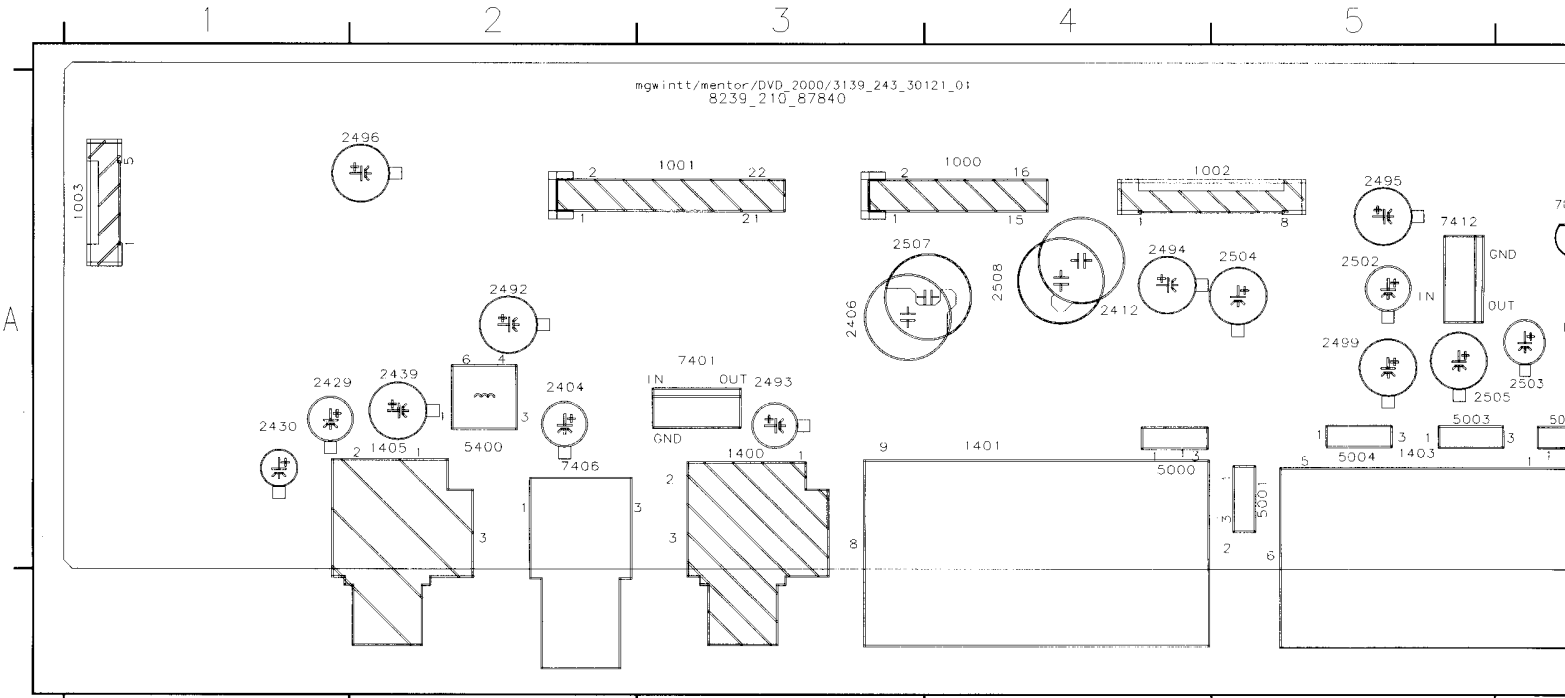

2400 A6	2422 A4	2447 A7	2467 A1	2484 A2	3413 A5	3444 A7	3444 A7	3444 A7	3444 A7	3444 A7	3444 A7	3444 A7	3444 A7
2401 A6	2423 A4	2448 A7	2468 A1	2485 A2	3414 A5	3445 A7	3445 A7	3445 A7	3445 A7	3445 A7	3445 A7	3445 A7	3445 A7
2402 A6	2424 A4	2449 A7	2469 A1	2486 A2	3415 A5	3446 A7	3446 A7	3446 A7	3446 A7	3446 A7	3446 A7	3446 A7	3446 A7
2403 A6	2425 A4	2450 A8	2470 A1	2500 A4	3416 A6	3447 A7	3447 A7	3447 A7	3447 A7	3447 A7	3447 A7	3447 A7	3447 A7
2404 A6	2426 A4	2451 A1	2471 A1	2501 A4	3417 A6	3448 A7	3448 A7	3448 A7	3448 A7	3448 A7	3448 A7	3448 A7	3448 A7
2405 A5	2427 A4	2452 A1	2472 A1	2502 A4	3418 A6	3449 A7	3449 A7	3449 A7	3449 A7	3449 A7	3449 A7	3449 A7	3449 A7
2406 A5	2428 A4	2453 A1	2473 A1	2503 A4	3419 A6	3450 A7	3450 A7	3450 A7	3450 A7	3450 A7	3450 A7	3450 A7	3450 A7
2407 A5	2429 A4	2454 A1	2474 A1	2504 A4	3420 A6	3451 A7	3451 A7	3451 A7	3451 A7	3451 A7	3451 A7	3451 A7	3451 A7
2408 A5	2430 A4	2455 A1	2475 A1	2505 A4	3421 A6	3452 A7	3452 A7	3452 A7	3452 A7	3452 A7	3452 A7	3452 A7	3452 A7
2409 A5	2431 A4	2456 A1	2476 A1	2506 A4	3422 A6	3453 A7	3453 A7	3453 A7	3453 A7	3453 A7	3453 A7	3453 A7	3453 A7
2410 A6	2432 A4	2457 A1	2477 A1	2507 A4	3423 A6	3454 A7	3454 A7	3454 A7	3454 A7	3454 A7	3454 A7	3454 A7	3454 A7
2411 A6	2433 A4	2458 A1	2478 A1	2508 A4	3424 A6	3455 A7	3455 A7	3455 A7	3455 A7	3455 A7	3455 A7	3455 A7	3455 A7
2412 A6	2434 A4	2459 A1	2479 A1	2509 A4	3425 A6	3456 A7	3456 A7	3456 A7	3456 A7	3456 A7	3456 A7	3456 A7	3456 A7
2413 A6	2435 A4	2460 A1	2480 A1	2510 A4	3426 A6	3457 A7	3457 A7	3457 A7	3457 A7	3457 A7	3457 A7	3457 A7	3457 A7
2414 A6	2436 A4	2461 A1	2481 A1	2511 A4	3427 A6	3458 A7	3458 A7	3458 A7	3458 A7	3458 A7	3458 A7	3458 A7	3458 A7
2415 A6	2437 A4	2462 A1	2482 A1	2512 A4	3428 A6	3459 A7	3459 A7	3459 A7	3459 A7	3459 A7	3459 A7	3459 A7	3459 A7
2416 A6	2438 A4	2463 A1	2483 A1	2513 A4	3429 A6	3460 A7	3460 A7	3460 A7	3460 A7	3460 A7	3460 A7	3460 A7	3460 A7
2417 A6	2439 A4	2464 A1	2484 A1	2514 A4	3430 A6	3461 A7	3461 A7	3461 A7	3461 A7	3461 A7	3461 A7	3461 A7	3461 A7
2418 A6	2440 A4	2465 A1	2485 A1	2515 A4	3431 A6	3462 A7	3462 A7	3462 A7	3462 A7	3462 A7	3462 A7	3462 A7	3462 A7
2419 A6	2441 A4	2466 A1	2486 A1	2516 A4	3432 A6	3463 A7	3463 A7	3463 A7	3463 A7	3463 A7	3463 A7	3463 A7	3463 A7
2420 A6	2442 A4	2467 A1	2487 A1	2517 A4	3433 A6	3464 A7	3464 A7	3464 A7	3464 A7	3464 A7	3464 A7	3464 A7	3464 A7

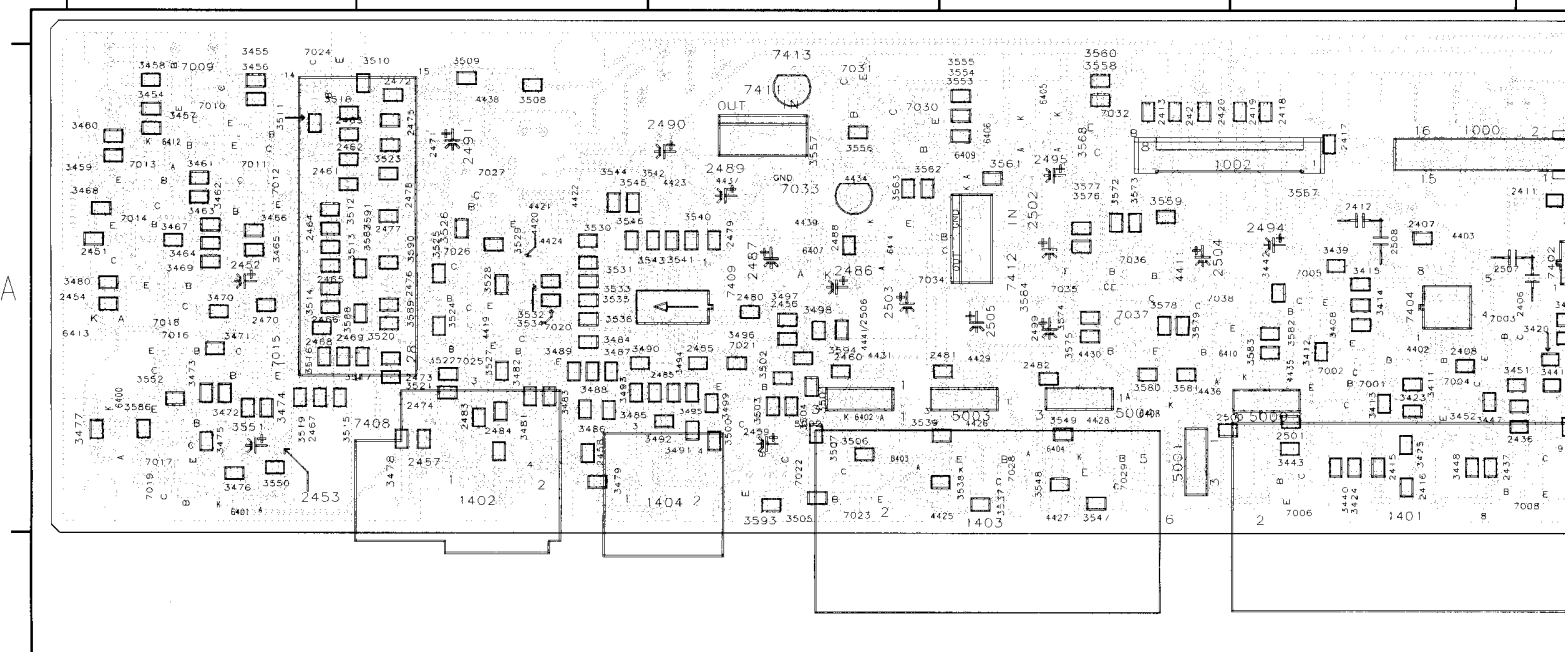



A/V Pwb (DVD 711)

1002	B3	1005	B2	1405	B7	2007	B5	2029	A2	2039	A6	2103	B3	2132	B4	5000	B1
1003	B7	1006	B5	2000	A1	2008	A5	2036	A7	2040	A7	2110	B1	2133	A3	5003	B4
1004	A1	1007	A3	2006	A4	2009	A5	2038	A3	2041	A6	2112	A4	2134	A1	5004	B4

1

2

3

4

5

mentor/DVD\_2000/DVD7:11/3:139\_243\_301  
8239 210 87830

A

B

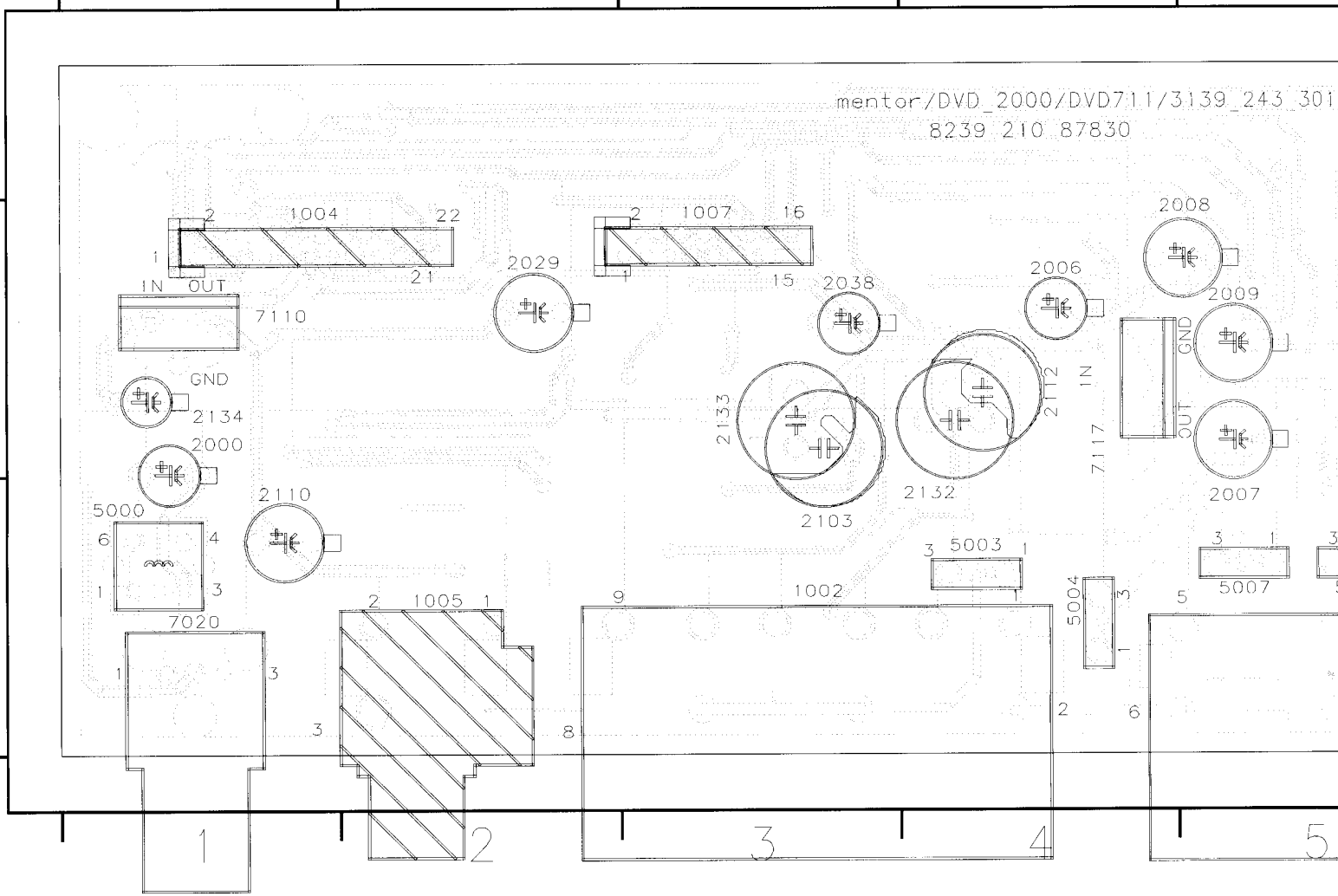

6	2103	B3	2132	B4	5000	B1	5005	B6	7020	B1
7	2110	B1	2133	A3	5003	B4	5006	B5	7110	A1
6	2112	A4	2134	A1	5004	B4	5007	B5	7117	A4

4

5

6

7

ntor/DVD\_2000/DVD711/3139\_243\_301.1.1\_01.  
8239 210 87830

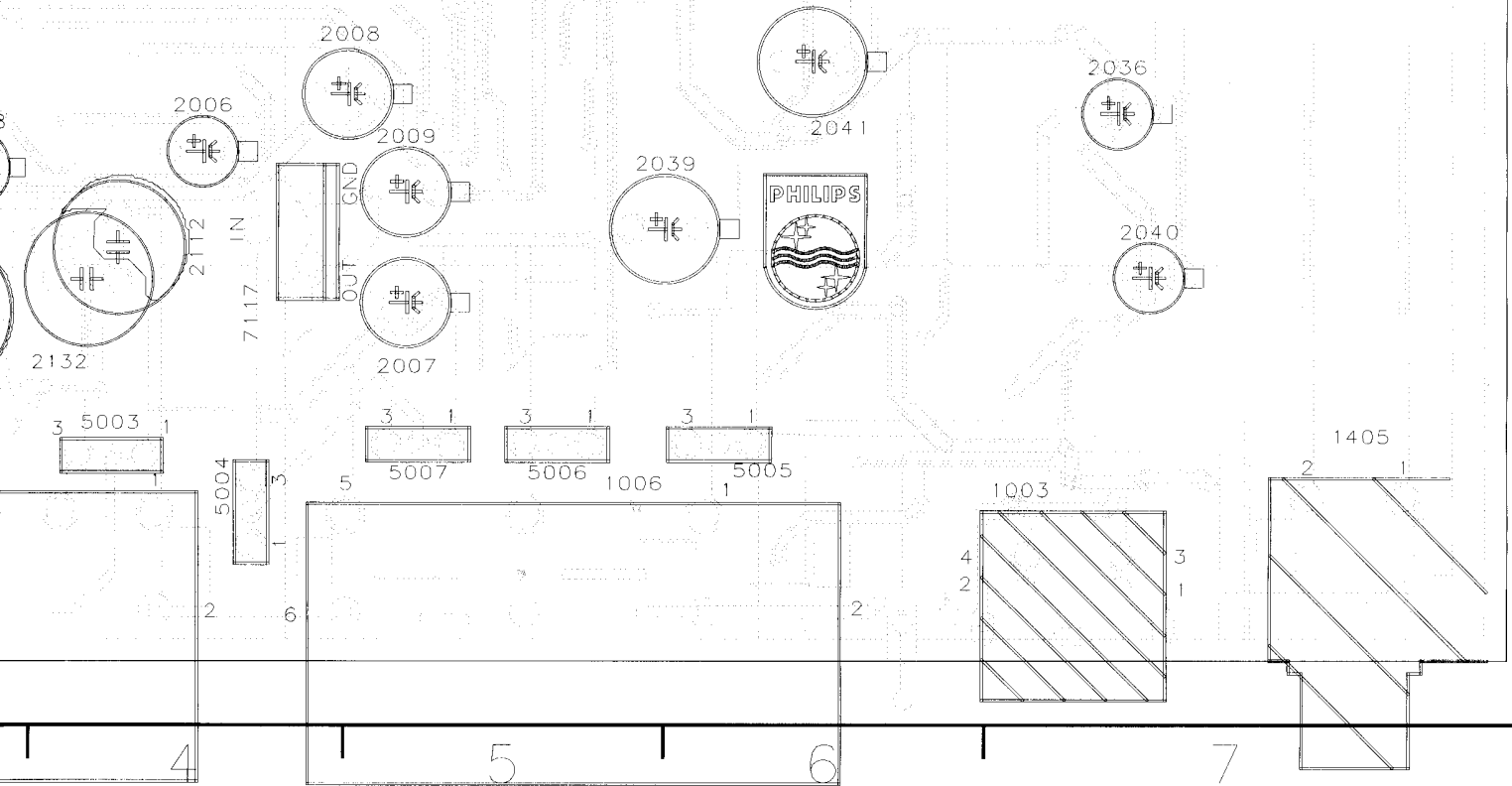





# 7. DIAGNOSTIC SOFTWARE : SCRIPT INTERFACES

## 7.1 DEALER SCRIPT

### 7.1.2 Contents of Dealer Script

#### 7.1.1 Purpose of Dealer Script

The dealer script can give a diagnosis on a standalone DVD player; no other equipment is needed to perform a number of hardware tests to check if the DVD player is faulty. The diagnosis is simply a "error" or "pass" message; no indication is given of faulty hardware modules. Only tests within the scope of the diagnostic software will be executed hence only faults within this scope can be detected.

The dealer script executes all diagnostic nuclei that do not need any user interaction and are meaningful on a standalone DVD player.

The nuclei called in the dealer script are the following (the number after each nucleus name corresponds with the number being on the local display when the nucleus is executed during the dealer script):

Nucleus		Description
VideoColSetupComm	9	Checks the I2C interface with the RGB video processor on the Audio/Video board (only for DVD players with RGB video processor).
VideoScartSwComm	8	Checks the I2C interface with the scart switch on the Audio/Video board
PapChksFl	7	Calculate and verify checksum of FLASH memory.
PapDramWrR	6	Pattern test of all locations in the DRAM(s).
PapI2cDisp	5	Checks the I2C interface with the slave processor on the display PCB.
PapS2bEcho	4	Checks the I2C interface to the basic engine.
PapI2cNvram	3	Checks the I2C interface with the NVRAM.
PapNvramWrR	2	Pattern test of all locations in the NVRAM
CompSdramWrR	1	Pattern test of all locations in the SDRAM(s).

CL 96532065\_001.eps  
120799

Figure 7-1

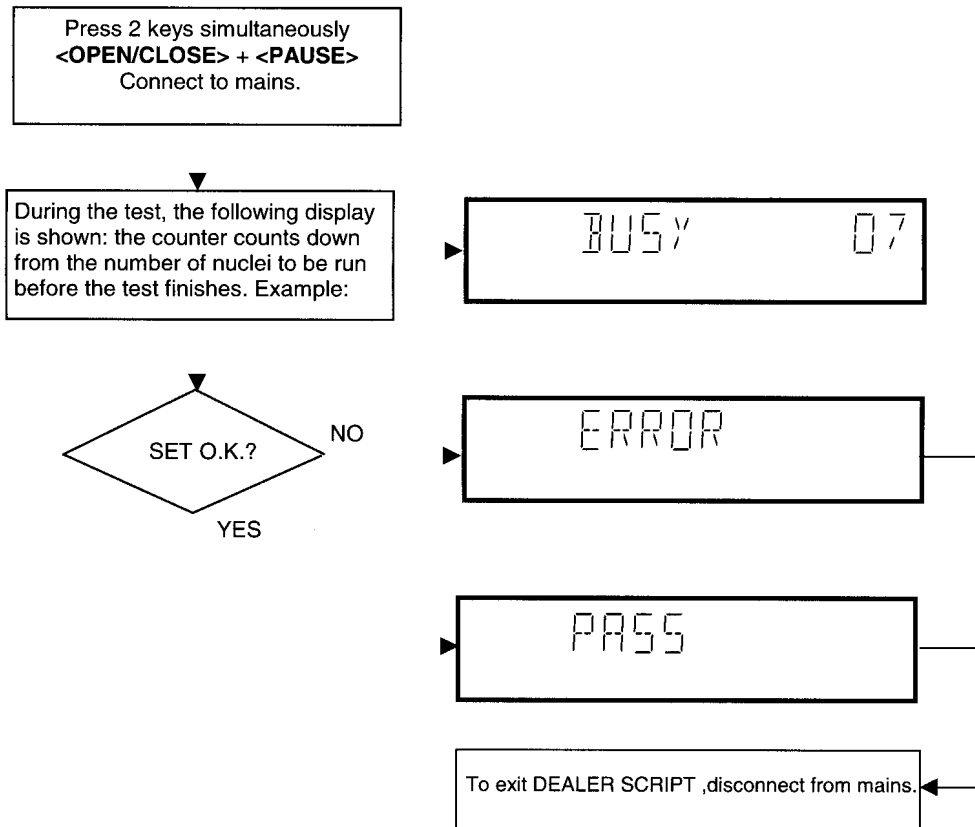

CL 96532065\_004.eps  
120799

7.2 PLAYER SCRIPT

7.2.1 Purpose of Player Script

The Player script will give the opportunity to perform a test that will determine which of the DVD player's modules are faulty, to read the error log and error bits and to perform an endurance loop test. To successfully perform the tests, the DVD player must be connected to a tv set to check the output of a number of nuclei. For DVDv2b a multi-channel amplifier, a set of 6 boxes and an external video source are necessary to test. To be able to check results of certain nuclei, the player script expects some interaction of the user (i.e. to approve a test picture or a test sound). Some nuclei (e.g. nuclei that test functionality of the Basic Engine module) require that the DVD player itself is opened, to enable the user to observe moving parts and approve their movement visually. Only tests within the scope of the diagnostic software will be executed hence only faults within this scope can be detected.

7.2.2 Contents of Player Script

The player script contains all nuclei that are useful on a DVD player that is connected to a tv-set and help to determine which module of the DVD player is faulty, as well as to read out the contents of the error logs.

7.2.3 Structure of Player Script

The player script consists of a set of nuclei testing the three hardware modules in the DVD player: the Display PWB, the Digital PWB and the Basic Engine.

Nuclei run by the player test need some user interaction; in the next paragraph this interaction is described. The player test is done in two phases:

1. Interactive tests: this part of the player test depends strongly on user interaction and input to determine nucleus results and to progress through the full test. Reading the error log and error bits information can be useful to determine any errors that occurred recently during normal operation of the DVD player.
2. The loop test will perform the same nuclei as the dealer test, but it will loop through the list of nuclei indefinitely.

7.2.4 Survey

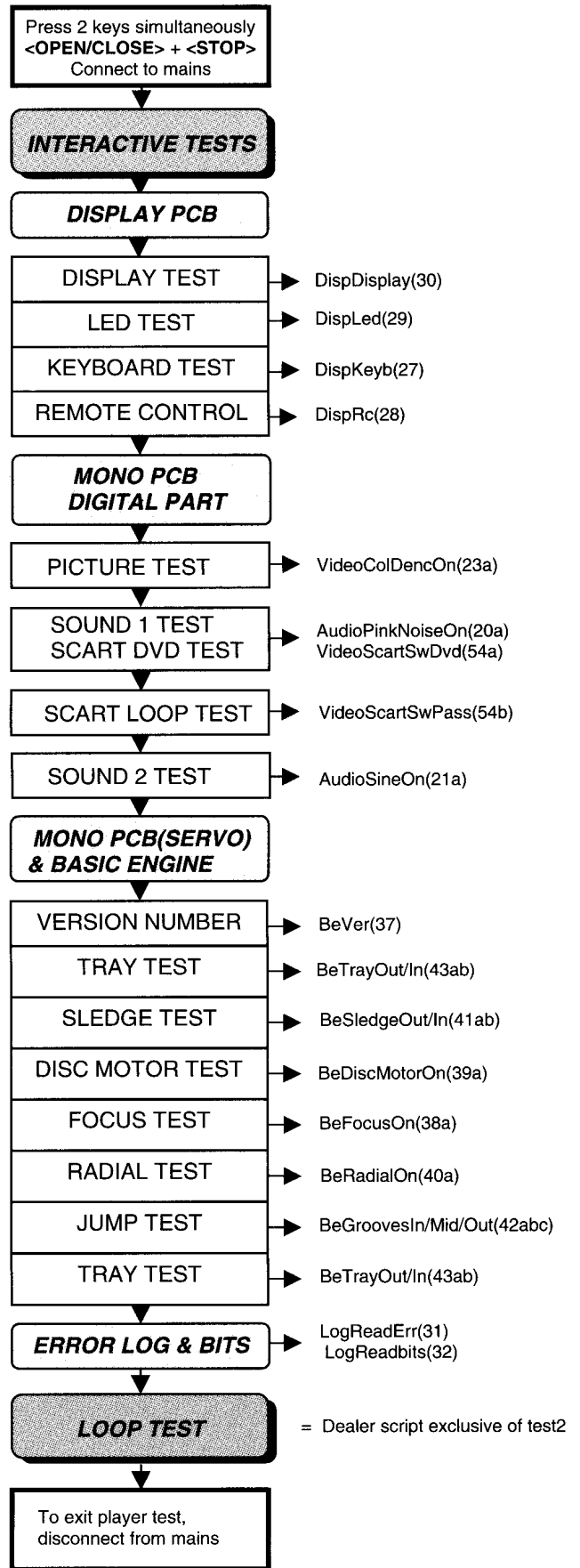



# 8. INTERACTIVE TESTS

## 8.1 DISPLAY PCB

### 8.1.1 DISPLAY TEST

The display test is performed by nucleus DispDisplay. By putting a series of test patterns on the local display, the local display is tested. To step through all different patterns, the user must either press PLAY (pattern is ok) or PAUSE (pattern was incorrect) to proceed to the next pattern. The display of patterns is continued in a cyclic manner until the user presses NEXT. If the user presses NEXT before all display patterns are tested, the DispDisplay nucleus will return TRUE (display test successful).

### 8.1.2 LED TEST

The LED(s) on the DVD player is (are) tested by nucleus DispLed. The user must check if the LED(s) is (are) lighted; if it is, press PLAY, if it is not, press PAUSE. By pressing NEXT the script will proceed to the next test. If the user presses NEXT before PLAY or PAUSE, the DispLed nucleus will return TRUE (LED test successful).

key id.	key
0	PLAY
1	NEXT
2	PREVIOUS
3	PAUSE
4	STOP
5	REPEAT
6	FTS
7	SCAN
8	BACKWARD
9	OPEN / CLOSE
A	FORWARD
B	SHUFFLE

CL 96532065\_008.eps  
120799

Figure 8-3

If any keys are detected more than once (due to hardware error), the key-code is displayed twice (or more), with the second digit increased by 1. If the user does not press all keys minimally once (in any order), the DispKeys nucleus will return FALSE and cause an error in the overall result of the player script. The user can leave the keyboard test by pressing the NEXT key on the local display of the DVD player for at least one full second. The result of the keyboard test is shown on local display as follows:

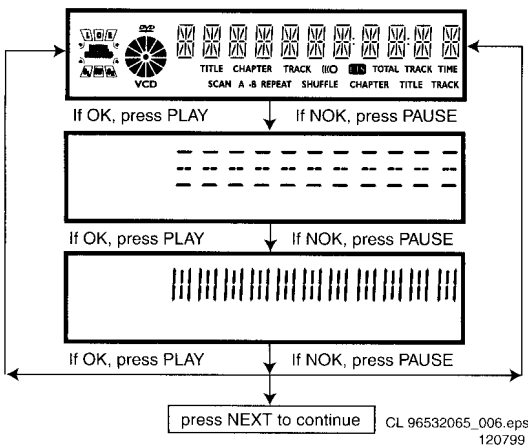

CL 96532065\_006.eps  
120799

Figure 8-1

### 8.1.3 KEYBOARD TEST

The keyboard of the DVD player is tested by nucleus DispKeyb. The user is expected to press all keys on the local keyboard once. The code of the key pressed is shown on the local display (1 hexadecimal digit) immediately followed by a (hexadecimal) number indicating how many times that key has been pressed. Example of the local display during this test:

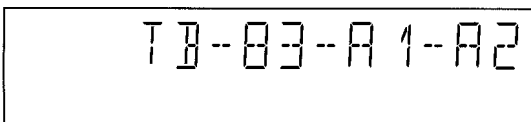

CL 96532065\_007.eps  
120799

Figure 8-2

The key-codes displayed on the local display will scroll from right to left when the display gets full, the text "tb-" will remain on display.

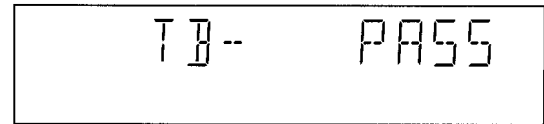

CL 96532065\_009.eps  
120799

Figure 8-4

Or

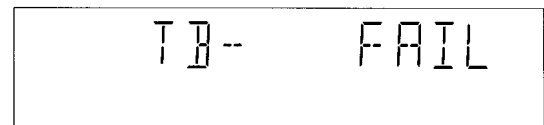

CL 96532065\_010.eps  
120799

Figure 8-5

Pressing NEXT on the local keyboard again will proceed to the next text.

### 8.1.4 REMOTE CONTROL TEST

The remote control of the DVD player is tested by nucleus DispRc. The user must press any key on the remote control just once. The codes of the key pressed will be shown on the local display in hexadecimal format. Example:

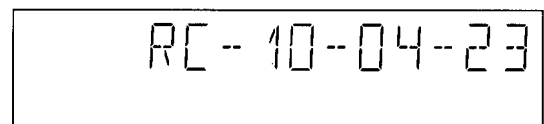

CL 96532065\_011.eps  
120799

Figure 8-6

In this example 23 is the hexadecimal code of the pressed RC key. The user can leave the remote-control test by pressing NEXT on the local keyboard of the DVD player. The remote control test is successful if a code was received before the user pressed the NEXT key; pressing the NEXT key before pressing a key on the remote control gives an error in the remote control test (note that the remote control test will also fail if a key on the remote control was pressed but no code was received). The remote control test does not check upon the contents of the received code, that is it will not be checked if the received code matches the key pressed. If desired, the user can manually check this code by using a code-table for the remote control key-codes.

RC Key id	Hexadecimal code
STANDBY	C
STOP	31
PLAY	2C
PLAY BACKWARD	2D
PAUSE	30
STEP FORWARD	F6
STEP BACKWARD	F5
FORWARD	28
FORWARD 4X	DF
FORWARD 8X	E0
BACKWARD	29
BACKWARD 4X	DE
BACKWARD 8X	DD
SLOW	22
SLOW 2	D8
SLOW BACKWARD	23
SLOW BACKWARD 2	DB
NEXT	20
PREVIOUS	21
CURSOR UP	58
CURSOR DOWN	59
CURSOR LEFT	5A
CURSOR RIGHT	5B
OK	5C
0	0
1	1
2	2
3	3
4	4
5	5
6	6
7	7
8	8
9	9
TOGGLE	C8
ANGLE	85
AUDIO	4E
SUBTITLES	4B
SUBTITLE ON/OFF	E3
ROOT MENU	54
TITLE MENU	71
MENU	D1
SETUP MENU	82
OSD ON/OFF	F
RETURN	83
RESUME	D7
SCAN	2A
SHUFFLE	1C
REPEAT	1D
A/B REPEAT	3D
TOGGLE SCART	43
OPEN/CLOSE	42
FTS	FB
KARAOKE	E4
OPTION	FA

CL 96532065\_012.eps  
120799

Figure 8-7

After pressing NEXT, the result of the remote control test is displayed on the local display of the DVD player as follows:

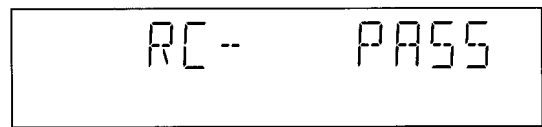

CL 96532065\_013.eps  
120799

Figure 8-8

Or

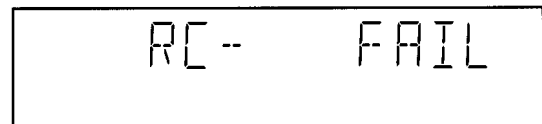

CL 96532065\_014.eps  
120799

Figure 8-9

Pressing NEXT on the local keyboard again will proceed to the next test.

## 8.2 MONO PCB DIGITAL PART

### 8.2.1 PICTURE TEST

The picture test is performed by putting a predefined picture (colour bar) on the display (nucleus VideoColDencOn) and asking the user for confirmation. The display will show the following message:

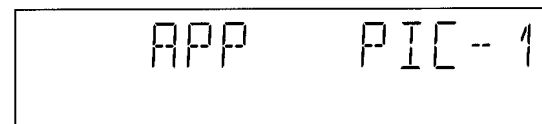

CL 96532065\_015.eps  
120799

Figure 8-10

By pressing PLAY the user confirms the test, pressing PAUSE will indicate the picture was invisible or incorrect. Pressing NEXT will proceed to the next test

### 8.2.2 SOUND 1 & SCART DVD TEST

The first soundtest is performed by starting a pink noise sound that needs confirmation from the user (nucleus AudioPinkNoiseOn); the display will show the following message very shortly:

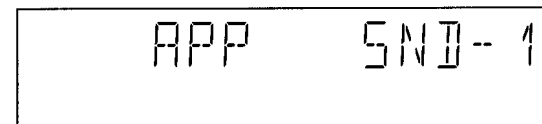

CL 96532065\_016.eps  
120799

Figure 8-11

This sound will only be audible from version cut3.1 of Sti5505(item7503 on mono board) onwards. After starting up sound 1, SCART loop-trough will be simultaneously active during this test. SCART loop-trough will be measured with the aid of an external video source.

When entering the SCART loop-trough, the local display indicates:



CL 96532065\_017.eps  
120799

Figure 8-12

On the TV screen a colour bar (generated by nucleus VideoColDencOn) is visual and the internally generated pinknoise is audible. By pressing PLAY the user confirms the test, pressing PAUSE will indicate the sound was inaudible or incorrect. Pressing NEXT will proceed to the next test; if the user presses NEXT without pressing PLAY or PAUSE first, the result of this test will be TRUE (sound ok). By pressing the NEXT button there will be switched over to the external source, this must become now visible on the TV screen (using the SCART). The local display indicates:



CL 96532065\_016.eps  
120799

Figure 8-13

The internally generated colour bar is still available on the CVBS and Y/C outputs. And the pinknoise-signal is still available on the cinch audio outputs. By pressing the PREV button, the internal generated colour bar becomes visual again. The test can be left by pressing the NEXT key for more than one second.

### 8.2.3 SOUND 2 TEST

The second soundtest is performed by producing a sine sound (nucleus AudioSineOn). The signal can be stopped by pressing the STOP-key. The display will show the following message:

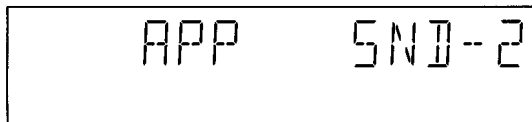

CL 96532065\_019.eps  
120799

Figure 8-14

By pressing PLAY the user confirms the test, pressing PAUSE will indicate that something went wrong. Pressing NEXT will proceed to the next; if the user presses NEXT without pressing PLAY or PAUSE first, the result of this test will be TRUE (sound ok).

## 8.3 BASIC ENGINE

### 8.3.1 VERSION NUMBER

In the basic engine tests, the version number of the Basic Engine will be shown first, as the following example:

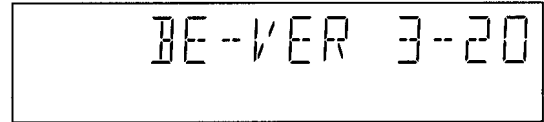

CL 96532065\_020.eps  
120799

Figure 8-15

By pressing the NEXT key, the Basic Engine tests are started.

### 8.3.2 TRAY TEST

First, the tray is tested. The purpose of this test is also to give the user the opportunity to put a disc in the tray of the DVD player. Some tests on the Basic Engine require that a disc(e.g. DVD MPTD test disc) is present in the player. At the end of the Basic Engine tests this tray test will be repeated solely to enable the user to remove the disc in the tray. The local display will look as follows:

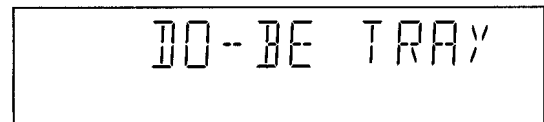

CL 96532065\_021.eps  
120799

Figure 8-16

By pressing PLAY or PAUSE the user can toggle the position of the tray. Note that this test will not contribute to the test result of the Basic Engine. Pressing NEXT will proceed to the next test, after the tray has been closed (by the software) if it was open.

### 8.3.3 SLEDGE TEST(visual test)

The second Basic Engine test tests the sledge; the user can move the sledge as many times as desired by using PLAY (nucleus BeSledgeOut) and PAUSE (nucleus BeSledgeIn). Pressing NEXT on the local keyboard proceeds to the next test. Note that this test will not contribute to the test result of the Basic Engine. The local display will look as follows during the sledge test:

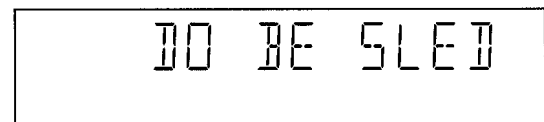

CL 96532065\_022.eps  
120799

Figure 8-17

### 8.3.4 DISC MOTOR TEST(visual test)

The third Basic Engine test tests the disc motor (nucleus BeDiscMotorOn); the local display looks as follows:

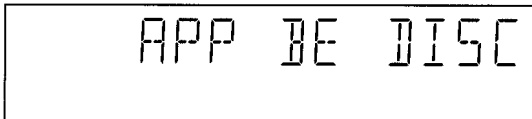

CL 96532065\_023.eps  
120799

Figure 8-18

By pressing PLAY the user confirms that the disc motor is running; pressing PAUSE indicates the disc motor does not work. Pressing NEXT proceeds to the next test, after a reset of the disc motor (nucleus BeDiscMotorOff). If the user presses NEXT before pressing PLAY or PAUSE, the result of this test will be TRUE (disc motor is running).

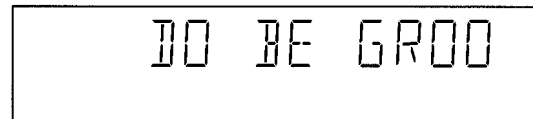

CL 96532065\_026.eps  
120799

Figure 8-21

The user can switch between the three different types of groove settings by pressing PLAY (forward to next nucleus in the list In-Mid-Out) or PAUSE (backward in the list In-Mid-Out). This is done in a cyclic manner; note that this test will not contribute to the test result of the Basic Engine. Pressing NEXT proceeds to the next test, after the disc motor has been shut off with a call to nucleus BeDiscMotorOff.

### 8.3.5 FOCUS TEST(visual test)

The fourth Basic Engine test tests the focussing; first focussing is turned on by calling nucleus BeFocusOn. The display will look as follows:

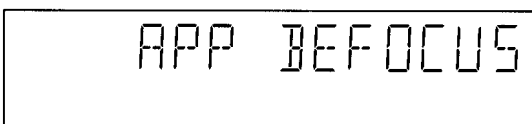

CL 96532065\_024.eps  
120799

Figure 8-19

By pressing PLAY the user confirms that the focussing was successful; pressing PAUSE indicates a focussing failure. Pressing NEXT proceeds to the next test after a reset of the focussing (nucleus BeFocusOff); if NEXT is pressed before PLAY or PAUSE, the result of this test will be TRUE (focus successful).

### 8.3.8 TRAY TEST

As a last action for the Basic Engine tests, the tray test is repeated. The local display will look as follows:

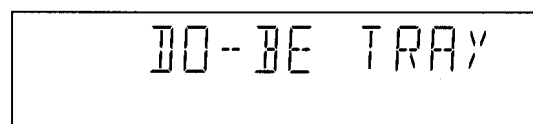

CL 96532065\_027.eps  
120799

Figure 8-22

This test is meant to give the user the opportunity to remove the disc in the tray. The tray position can be toggled using the PLAY and PAUSE key. The tray will be closed (by the software, if it is open) before proceeding to the next test when the user presses the NEXT key.

### 8.3.6 RADIAL TEST(visual & listening test)

The fifth Basic Engine test tests the radial functionality (nucleus BeRadialOn); the local display looks as follows:

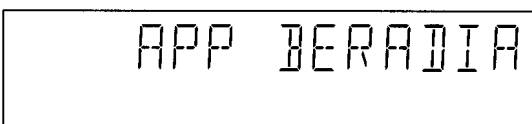

CL 96532065\_025.eps  
120799

Figure 8-20

By pressing PLAY the user confirms that the radial function worked; pressing PAUSE indicates the function does not work. Pressing NEXT proceeds to the next test, after a reset of the radial (nucleus BeRadialOff). If the user presses NEXT before pressing PLAY or PAUSE, the result of this test will be TRUE (radial successful).

### 8.3.7 JUMP TEST(listening test)

The sixth and last Basic Engine test tests the jumping by calling nuclei BeGroovesIn, BeGroovesMid and BeGroovesOut. During this test, the local display looks as follows:

**8.3.9 ERROR LOG**

Reading the error log and error bits information can be useful to determine any errors that occurred recently during normal operation of the DVD player. Reading the error log is done by nucleus LogReadErr. The display during the errorlog readout looks as follows :

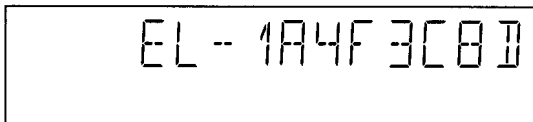

**Figure 8-23**

By pressing PLAY or PAUSE the user can move forward or backward (respectively) through the logged error codes. The highlighted number indicates which errorcode is currently on display (in the example above, errorcode number 4 is displayed). If "0000" is displayed at all positions, the error log is empty. Display of the logged errors is done in a cyclic manner. The errorcode with the lowest highlighted number is the most

recent. By pressing NEXT on the local keyboard, the user can proceed to the next test.

**8.3.10 ERROR BITS**

Reading the error bits is done by nucleus LogReadBits. The display during the errorbits readout looks as follows:



**Figure 8-24**

Only the set errorbits will be shown by their (decimal) number. Refer to the appropriate documentation for the explanation of each bit number. If the display only shows "EB-0", no error bits were set. By pressing NEXT the user can continue to the next test.

See table below:

Error log / bits table	Read ERROR LOG in player script	Read ERROR BITS in player script
Basic engine errors	Value:	Value:
Command to the Basic Engine not allowed in this state or unknown command	150101	8
Parameter(s) from the command to the Basic Engine is not valid	150102	7
Sledge could not be moved to the inner home position	150103	6
Focus failure	150104	5
Turntable motor speed could not be reached within timeout	150105	4
Radial servo could not get on track on the disc	150106	3
PLL could not lock in the accessing or tracking state	150107	2
Subcode or sector information could not be read	150108	1
requested subcode could not be found	150109	16
Tray could not be closed or opened completely	15010A	15
TOC could not be read within timeout	15010B	14
The requested seek on the disc could not be executed	15010C	13
A requested lead-in is not on the disc	15010D	12
A non existing burst cutting area is requested	15010E	11
S2b communication error	1501F0	10
S2b communication error	1501F1	9
S2b communication error	1501F3	24
S2b communication error	1501F4	23
S2b communication error	1501F5	22
Digital PWB errors		
Communication error with the Sti 5505	90000	32
Communication error with the Sti 5505	90001	31
Display processor errors		
Communication error with the display processor	190000	40

8.4 LOOP TEST

At the start of the loop test, the display will show the result of the interactive player test:

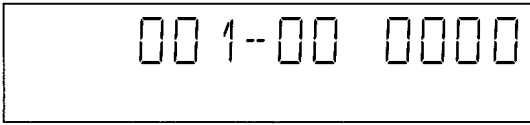

Figure 8-25

The left side of the display contains a 3-digit code, which can have a value between 000 and 111. These values are to be interpreted as follows:

Displayed Value	Indication for each module		
	Basic Engine	Mono PCB	Display PCB
000	ok	ok	ok
001	ok	ok	faulty
010	ok	faulty	ok
011	ok	faulty	faulty
100	faulty	ok	ok
101	faulty	ok	faulty
110	faulty	faulty	ok
111	faulty	faulty	faulty

Figure 8-26

The loop test will perform the same nuclei as the dealer test, but it will loop through the list of nuclei indefinitely. The display of the DVD player will display not only the three digits indicating correct/faulty modules and the last found error code (as mentioned, faults are detected as far as they can be within the scope of the diagnostic software), but also a loop counter indicating how many times the loop has been gone through. Example:

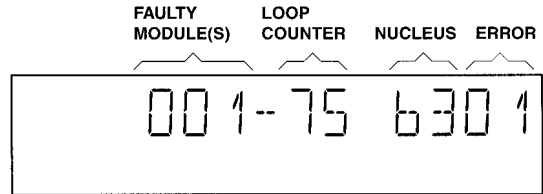

Figure 8-27

The number after the hyphen indicates the number of times the loop test has been performed; the 4 digits at the right side of the display show the last error that was found when running the loop test: the leftmost two digits of this code indicate which nucleus resulted in a fault; the rightmost two digits refer to the faultcode within that nucleus. For further explanation of this error code, see list of error codes below.

ERROR CODES LOOP TEST

ERROR CODE	NUCLEUS NUMBER	ERROR DESCRIPTION
0601	6	Calculated checksum of FLASH is not correct
0901	9	The DVD DRAM is faulty
1104	11	I2C bus busy before start
1102		NVRAM access time-out
1103		No NVRAM Acknowledge
1104		NVRAM reply time-out
1201	12	I2C bus busy
1202		I2C bus not working
1203		Slave controller not responding
1204		Slave response is not correct
1301	13	Parity error from basic engine to serial
1302		Parity error from serial to basic engine
1303		No communication between serial and basic engine
1304		Communication time-out error
1601	16	The SDRAM is faulty

Figure 8-28

8.5 Servicing DVD module and MONO board

Return the defective unit complete assembled in original package to Philips Consumer Service in Eindhoven

The DVD module(Basic Engine and the mono board) has to be exchanged completely in case of failure. A new module for DVD750/001 can be ordered with codenumber 3104 129 51980.

8.5.1 Reprogramming of new mono boards.

**Caution**

***This information is confidential and may not be distributed. Only a qualified service person should reprogram the mono board.***

After replacement of the mono board, all the customer settings and also the region code will be lost. Reprogramming of the mono board will put the player back in the state in which it has left the factory, i.e. with the default settings and the allowed region code.

Reprogramming is limited to 25 times  
 When the counter reaches 25, reprogramming is not possible anymore  
 Reprogramming will be done by way of the remote control.  
 Put the player in stop mode, no disc loaded.  
 Press the following keys on the remote control:  
 <PLAY> followed by numerical keys <1> <5> <9>  
 The display shows: "- - - - -"

Press now successively the following keys :

for DVD711/751 : <0><3><8> <0><0><0><0><0><0><0><0><0><0> PAL/NTSC

Press <PLAY> again.  
 The TV screen will become BLUE during a short time to confirm that the mono board has been reprogrammed, then the set goes to standby mode.

CL 06532049\_001.eps  
250400

Figure 8-29

8.5.2 Reset of Virgin Mode

After the player has been powered up for test by the dealer, it would have gone through the Virgin Mode. It is possible to reset the settings made during that mode before the delivery of player to the customer. This can be done as shown in the following diagram:

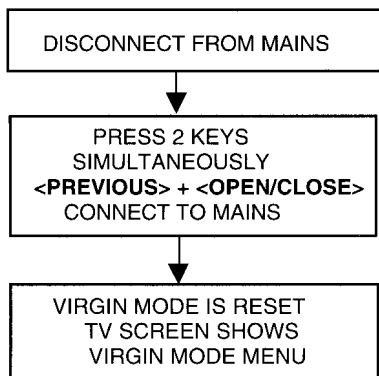

CL 96532065\_034.eps  
120799

**TRADE MODE**

*When the player is in Trade Mode, the player cannot be controlled by means of the front key buttons, but only by means of the remote control.*

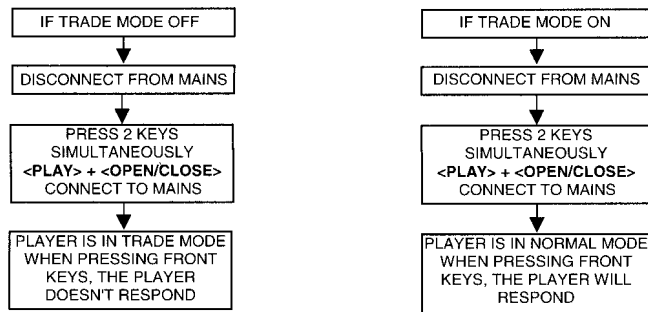

CL 96532065\_035.eps  
120799

Figure 8-31

Figure 8-30

# 9. Test instructions Display board

## 9.1 Display board

### 9.1.1 Introduction

These test instructions are written for all versions of the display PCB 3104 123 42230. The contents of the PCB can be split up into next blocks:

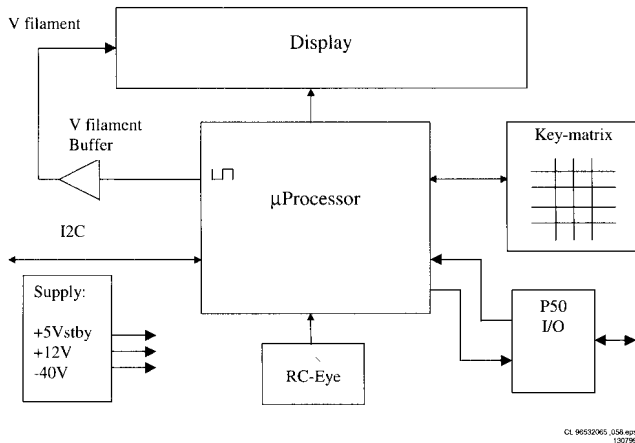

Figure 9-1

### 9.1.2 Functionality description:

The essential component of the display PCB is the µP (slave). This slave works on an 8MHz resonator and has a reset circuit that is triggered by the +5Vstby. After the reset pulse, the standby control line will release the reset of the host µP. This host µP will then initialise the slave. In addition, when going to stand-by, the slave will put the host µP in reset. When the slave receives the right IR or key code to leave the standby mode, the reset of the host µP will be released.

Other slave functions are:

- Square signal generator to generate the filament voltage, which is required for an AC FTD.
- Generates the grid and segment scanning for the FTD.
- Generates a scanning grid for the keys (separated from display scanning).
- Has inputs for RC (RC5 and RC6) and P50 (P50 controller is built in).

### 9.1.3 General

- Oscilloscope measurements have been carried out using a Philips PM3392A.
- Impedance of measuring-equipment should be > 1MΩ.
- To do correct measurements we recommend to use supply 3122 427 21370, which is used in all "second generation B" DVD-players. Make sure that the main 3.3V has a 0.7A load.

### 9.1.4 Reset

Check next reset timing with an oscilloscope at pin 10 of the microprocessor.

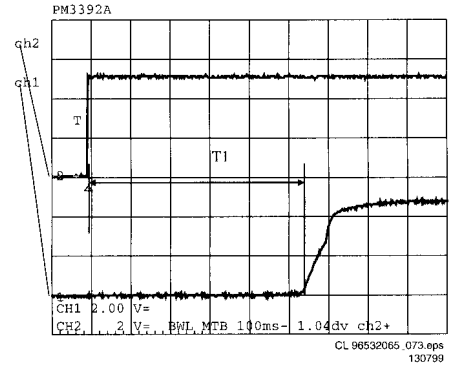

Figure 9-2

Timing: 400msec < T1 > 700msec.  
CH1: +5Vstby voltage at power on.  
CH2: Voltage at pin 10.

### 9.1.5 Display steering

Check next timing and level for all grid-lines (G1 r G14).

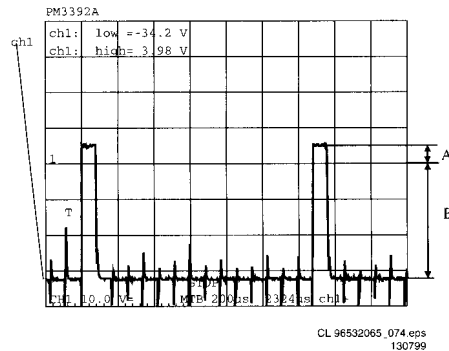

Figure 9-3

1. Check level A: +4V5 +/-10% for grid lines 1 => 11
2. Check level A: +4V0 +/-10% for grid lines 12 => 14
3. Check level B: -33V +/-10%
4. Check timing and levels of segment-lines P1 => P10:

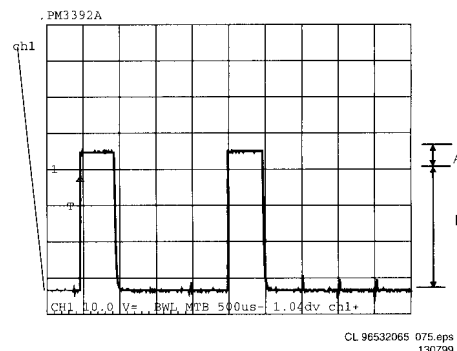

Figure 9-4



Level A: +4V5 +/-10%

Level B: -33V +/-10%

The data on these segment lines depend on the characters that are displayed.

The characters can be set by sending I2C commands to the display.

See the Slave URS how to send a display command.

### 9.1.6 Key-matrix

Connect an extra 10kΩ pull-up to pin 36 and 37 of the μP and check next matrix scanning at these pins.

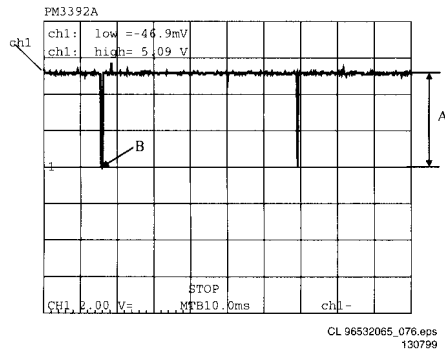

Figure 9-5

Level A: 5.0V +/-7%

Level B: 0V +/-200mV

Check matrix scanning from pin 26 until 33 of the μP.

The results should be the same as the diagram above.

### 9.1.7 I.R. receiver

Check at pin 23 of the μP if this line switches from low (< 0.3V) to high (> 4.5V), while pressing a key on a Philips RC5 or RC6 remote control.

### 9.1.8 Karaoke interface

The karaoke interface (4 lines) is a single direction communication.

This means that it consists of four μP output lines.

The interface can be checked by setting or resetting these output-ports via the I2C bus.

Send next command via the I2C bus:

Address	: 0x70
Command byte	: 0x24
Data byte	: xxxxabcd
Where	: a = Karaoke reset.
	: b = Karaoke data.
	: c = Karaoke clock.
	: d = Karaoke strobe.

### 9.1.9 P50 interface

P50 is a bi-directional serial interface, which is used for communication between video equipment. For European sets, this communication goes via pin 10 of the scart-bus. In other regions, it can be a cinch bus at the back of the set.

1. Keep the μP in reset by short-circuiting emitter and collector of transistor 7108, via resistor 3100 and 3104 transistor 7101 is switched on.
2. Check the voltage at the P50 output connector 1118-5: < 200mV.

When the reset is released the μP output pin becomes low and transistor 7101 is switched off.

1. Check the voltage at the P50 output connector 1118-5: 4V9 +/-5%.
2. Check also the μP P50 input (μP pin 20): 5V +/-5%.
3. Connect the P50 line (connector 1118-5) to ground.
4. Check again the μP P50 input (μP pin 20): <0V3.

## 10. List of abbreviations

### 10.1 List of abbreviations

B	Buffered Video input Blue from DVD monoboard
BC_AUX	Blue or Chroma input from AUX-scart
BC_TV	Blue or Chroma output to TV-scart
C_ENC	Buffered Chroma input from DVD monoboard
CVBS	Buffered Composite video input from DVD monoboard
DC_OFF	Control signal to switch off $\hat{u}8V_{stby}$ and $+12V_{stby}$ during standby
DIG_OUT	Digital out
FBIN_AUX	Fast blanking input from AUX-scart
FBOU_TV	Fast blanking output to TV-scart
G	Buffered Video input Green from DVD monoboard
GIN_AUX	Video input Green from AUX-scart
GOUT_TV	Video output Green to TV-scart
HP_L	Audio output left to headphone and audio scart switch TEA6420
HP_R	Audio output right to headphone and audio scart switch TEA6420
KILL	Kill control signal for audio outputs and for soft mute of DAC
LIN_AUX	Audio input left from AUX-scart
LIN_TV	Audio input left from TV-scart
LOUT_AUX	Audio output left to AUX-scart
LOUT_TV	Audio output left to TV-scart
LRCLK	Left/Right clock
PCM_CLK	Audio system clock for DAC
PCM_OUT0	Audio serial output data
R	Buffered Video input Red from DVD monoboard
RCIN_TV	Red or Chroma input from TV-scart
RCOUT_TV	Red or Chroma output to TV-scart
RIN_AUX	Audio input right from AUX-scart
RIN_TV	Audio input right from TV-scart
ROUT_AUX	Audio output right to AUX-scart
ROUT_TV	Audio output right to TV-scart
SCL	I2C bus clock
SCLK	Audio serial bit clock
SDA	I2C bus data
SELECT	Control signal for video scart switches; high = TV ,low = AUX
SELECT_HIGH	Control signal for switching fast blanking and slow blanking signals; high = TV ,low = AUX
SLB_AUX	Slow blanking control signal from AUX-scart
SLB_TV	Slow blanking control signal to TV-scart
STANDBY	Control signal from STI5505 used to swith off $\hat{u}8V_{stby}$ and $+12V_{stby}$ during standby.
STEREO_L	Audio cinch output left
STEREO_R	Audio cinch output right
Y_ENC	Buffered Luma input from DVD monoboard
YCVBSIN_AUX	Luma or CVBS input from AUX-scart
YCVBSIN_TV	Luma or CVBS input from TV-scart
YCVBSOUT_AUX	Luma or CVBS output to AUX-scart
YCVBSOUT_TV	Luma or CVBS output to TV-scart
0/6/12	Scart switch control signal A/V board. 0V : loop through (AUX to TV), 6V : play 16:9 format, 12V : play 4:3 format



3116	4822 117 10833	10k 1% 0.1W
3117	4822 117 10833	10k 1% 0.1W
3118	4822 051 20101	100Ω 5% 0.1W
3119	4822 051 20101	100Ω 5% 0.1W
3120	4822 117 10833	10k 1% 0.1W
3121	4822 117 10833	10k 1% 0.1W
3122	4822 117 12955	2k7 1% 0.1W 0805
3123	4822 117 12955	2k7 1% 0.1W 0805
3124	4822 117 10833	10k 1% 0.1W
3126	4822 051 20101	100Ω 5% 0.1W
3127	4822 117 10833	10k 1% 0.1W
3129	4822 117 12955	2k7 1% 0.1W 0805
3130	4822 051 20101	100Ω 5% 0.1W
3131	4822 117 10833	10k 1% 0.1W
3132	4822 117 12955	2k7 1% 0.1W 0805
3135	5322 117 12487	1k RC12G 1% 0.125W
3136	5322 117 12487	1k RC12G 1% 0.125W
3137	4822 117 12635	10Ω 1% 0.125W
3138	4822 117 11139	1k5 1% 0.1W
3139	4822 117 11931	750Ω 1% 0.1W
3140	2120 108 92619	RST SM0805 ERJ6ΩN 2k2PM1
3141	5322 117 12487	1k RC12G 1% 0.125W
3142	5322 117 12487	1k RC12G 1% 0.125W
3143	5322 117 12487	1k RC12G 1% 0.125W
3144	4822 117 11953	560Ω 1% 0.1W
3145	2120 108 92625	RST SM 0805 ERJ6ΩN 5k6PM1
3146	4822 051 20008	0Ω jumper . (0805)
3147	2120 108 92616	RST SM 0805 ERJ6ΩN 1k2 PM1
3148	5322 117 12487	1k RC12G 1% 0.125W
3150	4822 117 11927	75Ω 1% 0.1W
3153	4822 051 20101	100Ω 5% 0.1W
3154	4822 117 11927	75Ω 1% 0.1W
3157	4822 117 11927	75Ω 1% 0.1W
3158	4822 117 11449	2k2 1% 0.1W
3159	4822 051 20101	100Ω 5% 0.1W
3160	4822 117 10833	10k 1% 0.1W
4xxx	4822 051 10008	0Ω 5% 0.25W (1206)
4xxx	4822 051 20008	0Ω 5% 0.25W (0805)

5000	4822 157 70601	100μH (920927085A)
5003	4822 242 10756	DSS306-92Y5S221M100
5004	4822 242 10756	DSS306-92Y5S221M100
5005	4822 242 10756	DSS306-92Y5S221M100
5006	4822 242 10756	DSS306-92Y5S221M100
5007	4822 242 10756	DSS306-92Y5S221M100



6001	4822 130 11087	BZX284-C15
6002	4822 130 11087	BZX284-C15
6003	4822 130 11087	BZX284-C15
6004	4822 130 11087	BZX284-C15
6005	4822 130 11087	BZX284-C15
6006	4822 130 11087	BZX284-C15
6007	4822 130 83757	BAS216
6008	4822 130 83757	BAS216
6009	4822 130 83757	BAS216
6010	4822 130 11087	BZX284-C15



7000	4822 130 60511	BC847B
7001	4822 130 42804	BC817-25
7002	4822 130 60373	BC856B
7004	4822 130 42804	BC817-25
7005	4822 130 42804	BC817-25
7006	5322 130 60159	BC846B
7007	5322 130 60159	BC846B
7008	5322 130 60159	BC846B
7009	4822 130 60373	BC856B
7010	5322 130 60159	BC846B
7011	5322 130 60159	BC846B
7012	4822 130 60373	BC856B
7013	5322 130 60159	BC846B
7014	5322 130 60159	BC846B
7015	4822 130 60373	BC856B
7016	5322 130 60159	BC846B
7017	5322 130 60159	BC846B
7018	5322 130 60159	BC846B
7019	5322 130 60159	BC846B
7020	4822 130 10845	GP1F32T
7103	4822 209 17423	UAD1328T
7104	4822 130 42804	BC817-25
7105	4822 130 42804	BC817-25

7108	4822 130 42804	BC817-25
7109	4822 130 42804	BC817-25
7110	4822 209 16978	LF33CV
7112	4822 130 42804	BC817-25
7114	4822 130 42804	BC817-25
7115	4822 209 30095	LM833D
7116	9322 141 80668	AD8073
7117	4822 209 72684	L7905CV

### Various

#### Various

0200	3139 247 50790	CAB FRONT DVD711/17X PNT PRT
0201	4822 459 10887	
0202	3139 240 00030	DVD LOGO DVD711
0203	3139 244 00160	LIGHT CONDUCTOR DVD950
0204	3139 247 50900	WINDOW DVD711/17X PNT PRT
0205	3139 247 51120	BTN POWER BK PNT PRT
0206	3139 244 00490	L/G HOLDER
0219	3139 247 50930	DOOR DVD711/17X PNT PRT
0220	3139 241 20110	DOOR SPRING
0232	3139 247 50340	COVER TOP
0240	3139 247 50870	BTN CONTROL DVD711/ 17X PNT PRT
0242	3139 247 51080	RING DVD711 ML PNT PRT
0244	3139 247 50750	FOOT ASSY DVD711
0245	3139 247 50750	FOOT ASSY DVD711
1005	3139 248 80380	PCBAS MITSUMI PSU DVD2000 USA
1014	3139 110 34220	FFC FOIL 22P/105/22P BD B
1018	3139 110 34230	FFC FOIL 16P/105/16P BD B

### Accessories

#### Various

0381	2422 076 00304	CABLE CINCH/CINCH 1M5 YE/RD/WH
0384	3139 228 82060	IRT ASSY RC283201/01 PACKED
0385▲	4822 321 11466	MAINS CORD /17
0387	3139 246 10210	IFU DVD711/17X